



PLI-3410

200Mbps HomePlug AV Wireless Combo Adapter

Quick Installation Guide

English

Ελληνικά

Deutsch

Português

Français

Svenska

Español

Slovenščina

Nederlands

Русский

Dansk

Polish

Italiano

Table of Contents

ENGLISH.....	3
DEUTSCH.....	7
FRANÇ AIS	11
ESPAÑ OL	15
NEDERLANDS	19
DANSK.....	23
ITALIANO.....	27
ΕΛΛΗΝΙΚΑ.....	31
PORTUGUÊ S	36
SVENSKA.....	40
SLOVENŠČINA	44
РУССКИЙ.....	48
POLSKI.....	52

Default Settings

IP Address	192.168.1.1
User Name / Password	admin
Wireless Mode	Enable
Wireless SSID	LevelOne
Security	None

This guide covers only the most common situations.
All detail information is described in the user manual.

English

Clip Installation

Installing the clip with PLI-3410

1. Follow the diagrams and direction to install the clip. (This is an example of EU clip.)

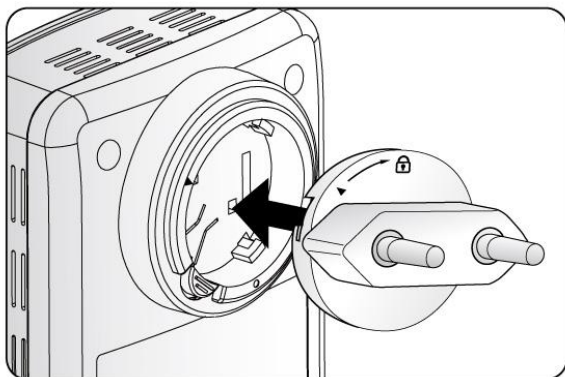

2. Please check the lock instruction on your clip. If you got the **“Triangle Lock”**, refer to right diagram.

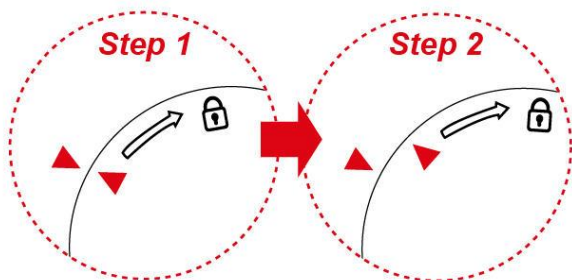
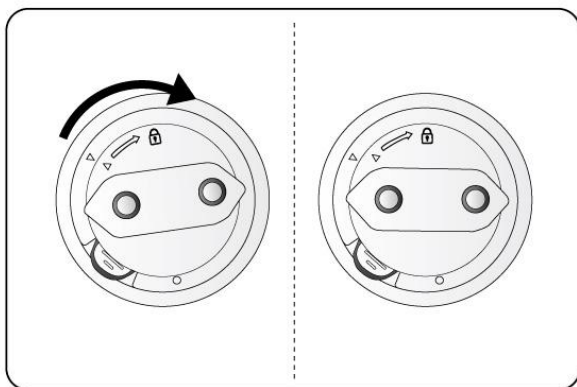

Please DO NOT remove or disassemble the socket clip frequently as this may cause serious damage to your HomePlug AV device!

*For WPS configuration please refer to PLI-3410 User Manual for more detail description.

Hardware Installation

1. Power Connection

Plug PLI-3410 into the wall outlet/socket

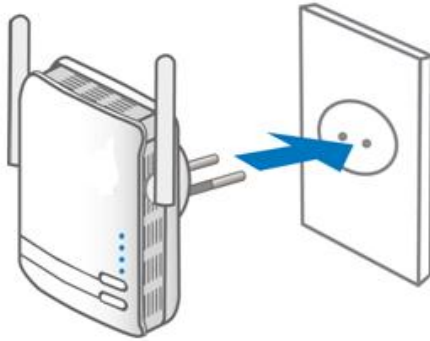

2. LAN & Wireless Connection

Install utility with LevelOne setup wizard.

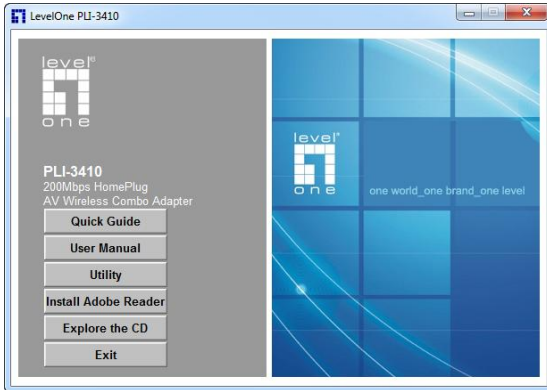

Configuring Web Browser

Open your web browser, enter the IP address of PLI-3410 which by default is **192.168.1.1**, and click “Go”. The user name and password window prompt will appear. The default user-name and password are both “**admin**”.

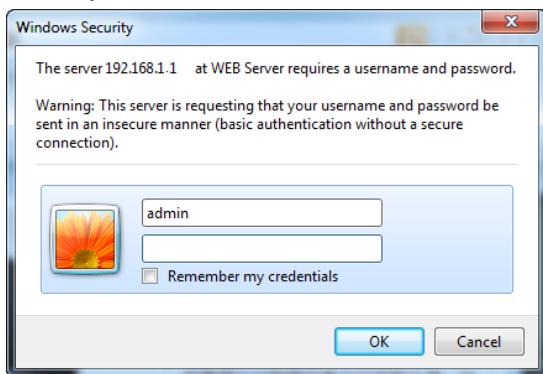

You are now successfully logon to PLI-3410 as the Status screen shows.

A screenshot of a web interface titled "Status". It displays various system and network parameters in a table-like format. The "LAN" section is expanded, showing IP, netmask, and MAC address. Other sections include System Information, Wireless LAN, and Power Line.

* System Information	
Model Name	PLI-3410
Firmware Version	1.04a-c (Mar 3 2010)
System Up Time	4 hours, 53 mins, 59 secs
Home URL	LevelOne
* LAN	
LAN IP Address	192.168.1.253
LAN Netmask	255.255.255.0
LAN MAC Address	00:04:ED:D0:1B:F8
* Wireless LAN	
WLAN Service	Enable
SSID1	wlan-ap
Channel	6
* Power Line	
Power Line Service	Enable
Connected Device	0

LevelOne

Installation des Stecker

Installation des Stecker für PLI-3410

1. Folgen Sie den Grafiken und Anweisungen, um den Stecker zu installieren. (Das Beispiel zeigt einen EU-Stecker.)

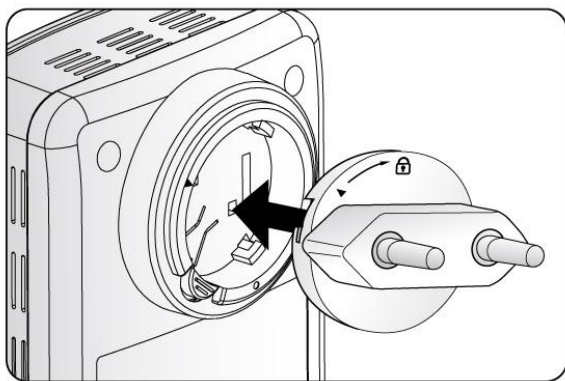

2. Bitte überprüfen Sie die Sperrvorrichtung an Ihrem Stecker. Sofern Sie eine "Dreiecks-Sperre" vorliegen haben, beachten Sie bitte das Schaubild auf der nächsten Seite.

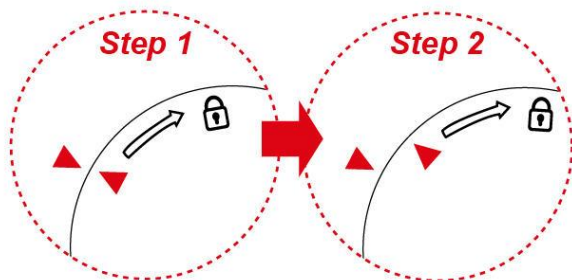
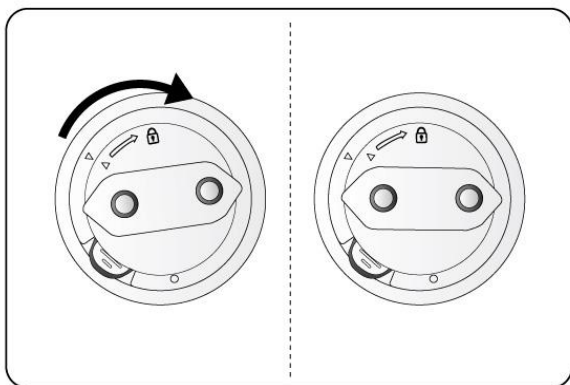

Bitte entfernen oder zerlegen Sie den Stecker **nicht regelmäßig**, da dies zu schweren Schäden an Ihrem HomePlug AV Adapter führen kann!

*Die detaillierte Anleitung zur Konfiguration des WPS finden Sie in der Bedienungsanleitung des PLI-3410.

Hardware Installation

1. Stromversorgung

Stecken Sie den PLI-3410 in die Steckdose.

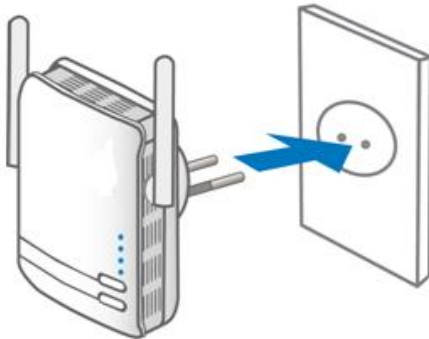

2. LAN- & Wireless-Verbindung

Installieren Sie die Software mit dem LevelOne-Installationsassistenten.

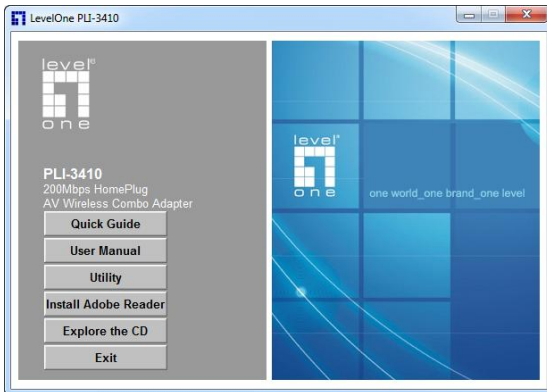

Konfiguration des Web-Browser

Öffnen Sie Ihren Web-Browser, geben Sie die Standard-IP Adresse des PLI-3410 mit **192.168.1.1** ein, und klicken auf **“Go”**. Das Fenster zur Eingabe des User-Name und Passwort öffnet sich. Der User-Name und das Passwort sind standardmäßig **“admin”**.

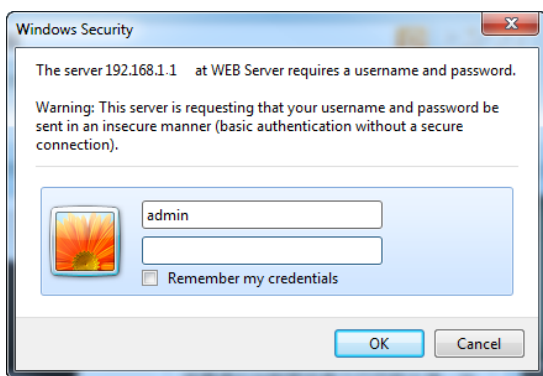

Sie haben sich nun erfolgreich auf dem PLI-3410 angemeldet und der Bildschirm mit der Status-Übersicht wird angezeigt.

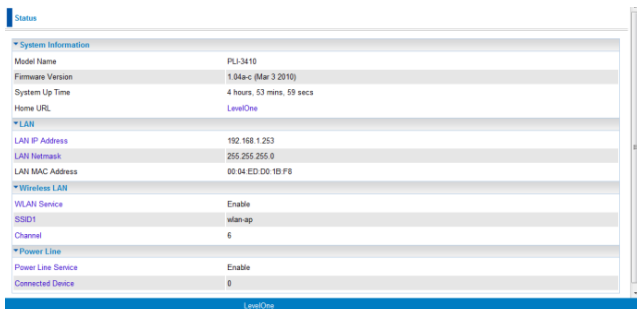
A screenshot of a web browser displaying a "Status" page. The page has a blue header with the word "Status" in white. Below the header is a table with system information. The table is organized into sections: System Information, LAN, Wireless LAN, and Power Line. Each section has a blue expand/collapse icon on the left. The table contains the following data:

* System Information	
Model Name	PLI-3410
Firmware Version	1.04a-c (Mar 3 2010)
System Up Time	4 hours, 53 mins, 59 secs
Home URL	LevelOne
* LAN	
LAN IP Address	192.168.1.253
LAN Netmask	255.255.255.0
LAN MAC Address	00:04:ED:D0:1B:F8
* Wireless LAN	
WLAN Service	Enable
SSID1	wlan-ap
Channel	6
* Power Line	
Power Line Service	Enable
Connected Device	0

At the bottom of the page, there is a blue bar with the text "LevelOne" in white.

Installation du clip

Installation du clip avec PLI-3410

1. Suivez les schémas et instructions pour installer le clip. (L'exemple donné ici est celui d'un clip européen.)

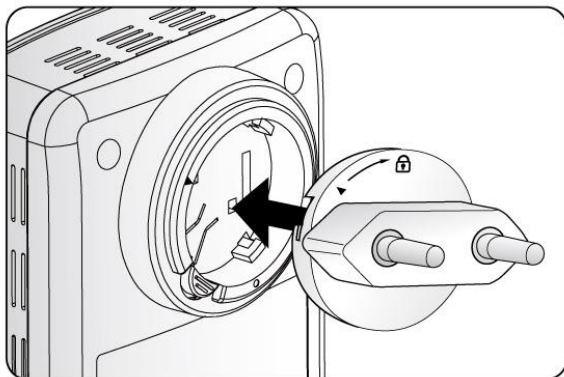

2. Veuillez consulter les instructions de verrouillage sur votre clip. Si vous avez le «**Verrou triangulaire**», veuillez vous reporter au diagramme correspondant.

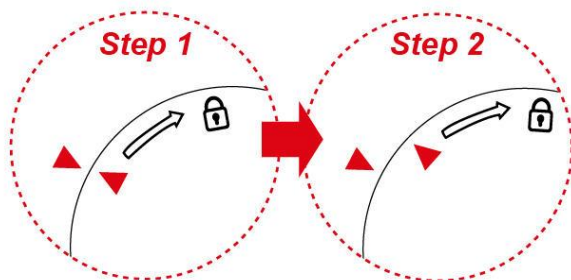
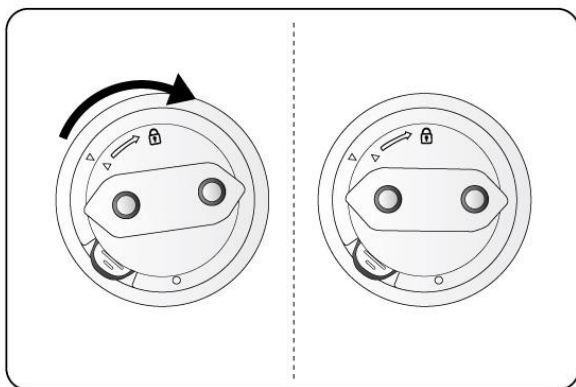

Veillez NE PAS enlever ou démonter le clip de la prise souvent car cela risque d'endommager votre appareil AV HomePlug !

*Pour la configuration WPS, veuillez vous reporter au Manuel de l'utilisateur du PLI-3410 pour une description plus détaillée.

Installation du matériel

1. Connexion de l'alimentation

Branchez le PLI-3410 sur une prise murale.

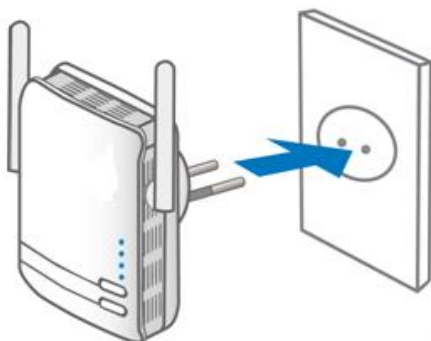

2. Connexion LAN et sans fil

Installez l'utilitaire avec l'assistant de configuration LevelOne.

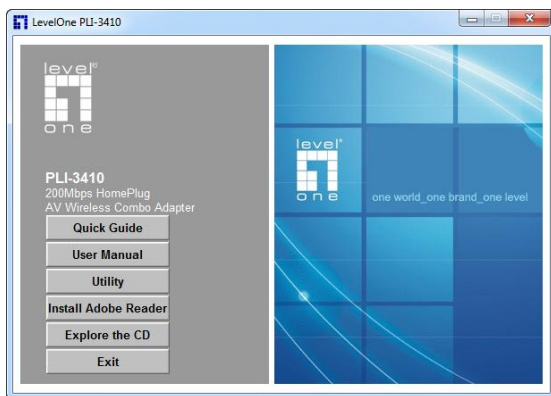

Configuration du navigateur web

Ouvrez votre navigateur web, entrez l'adresse IP du PLI-3410, qui est par défaut **192.168.1.1**, et cliquez sur «**Go**» (**Aller**). La fenêtre d'invite du nom d'utilisateur et du mot de passe s'affiche. Le nom d'utilisateur et le mot de passe par défaut sont tous deux «**admin**».

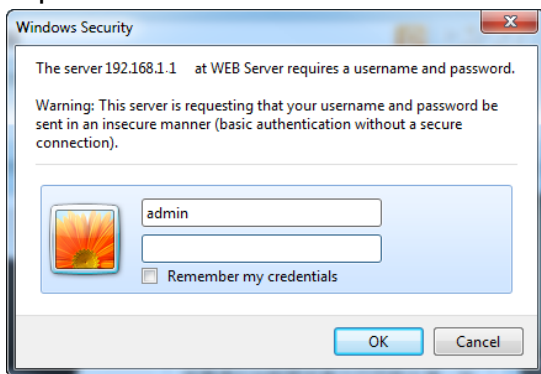

Vous avez ouvert une session avec succès sur le PLI-3410 lorsque la fenêtre Status (État) s'affiche.

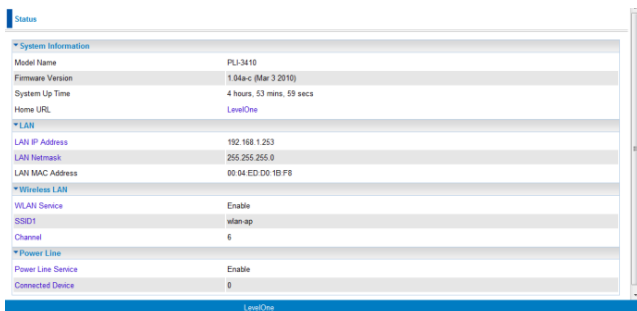
A screenshot of a web interface showing a "Status" page. The page has a blue header with the word "Status" in white. Below the header is a table of system information. The table is organized into sections: System Information, LAN, Wireless LAN, and Power Line. Each section has a blue expand/collapse icon. The table contains the following data:

System Information	
Model Name	PLI-3410
Firmware Version	1.04a-c (Mar 3 2010)
System Up Time	4 hours, 53 mins, 59 secs
Home URL	LevelOne
LAN	
LAN IP Address	192.168.1.253
LAN Netmask	255.255.255.0
LAN MAC Address	00:04:ED:00:1B:F8
Wireless LAN	
WLAN Service	Enable
SSID1	wlan-ap
Channel	6
Power Line	
Power Line Service	Enable
Connected Device	0

At the bottom of the page, there is a blue bar with the text "LevelOne" in white.

Instalación del Conector

1. Siga los diagramas e instrucciones para instalar el conector. (Este es un ejemplo con un conector tipo EU)

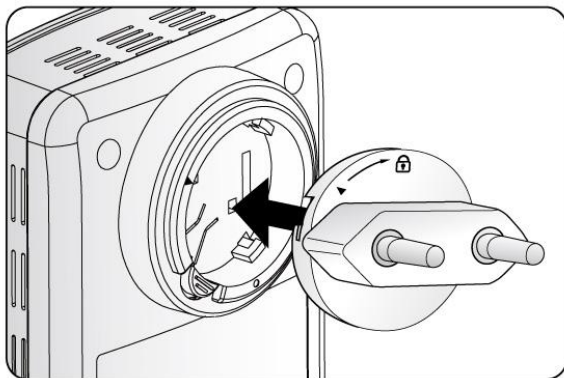

2. Por favor verifique las instrucciones de bloqueo en su conector. Refiérase al siguiente diagrama:

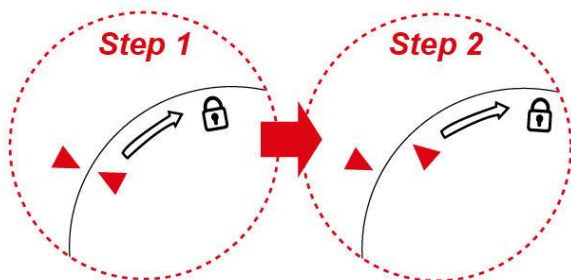
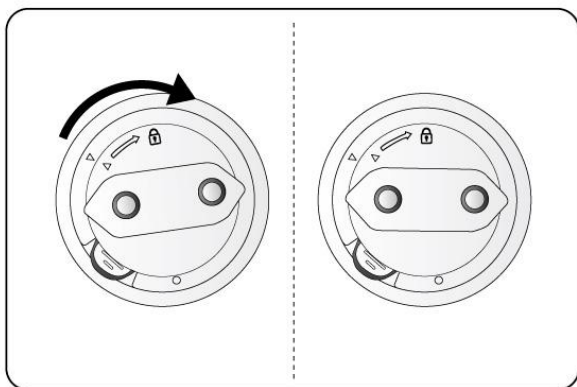

Por favor no des-ensamble el modulo del conector con frecuencia, esto podría causar daños serios en su dispositivo HomePlug!

*Para la configuración WPS, por favor refiérase al Manual de usuario del PLI-3410, donde encontrará instrucciones detalladas.

Instalación del Hardware

1. Conexión a la Red Eléctrica

Conecte el PLI-3410 a la toma de corriente

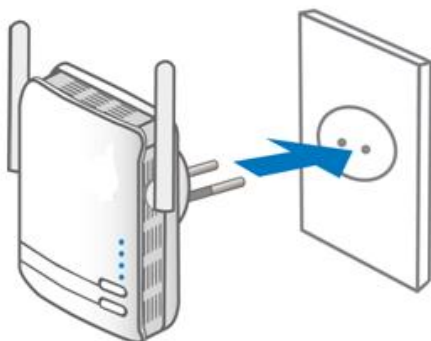

2. Conexión LAN e Inalámbrica

Instale el asistente de instalación LevelOne, este lo guiará paso a paso.

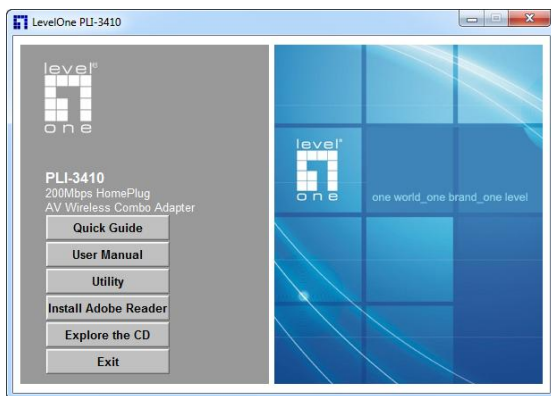

Configuración a través del Navegador Web

Abra su navegador Web e ingrese la dirección IP del PLI-3410, que por defecto es **192.168.1.1**. Aparecerá una ventana solicitando el ingreso de Nombre de Usuario y Contraseña; para ambos casos el valor por defecto es “**admin**”.

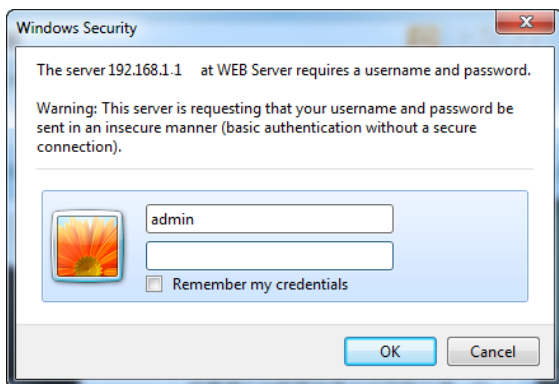

Usted se ha autenticado exitosamente en el PLI-3410, como la pantalla de Estado lo indica:

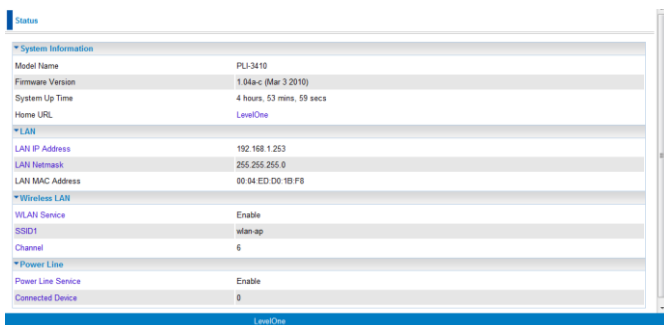
A screenshot of a web interface showing system status. The title is "Status". The content is organized into sections: "System Information", "LAN", "Wireless LAN", and "Power Line".

* System Information	
Model Name	PLI-3410
Firmware Version	1.04a-c (Mar 3 2010)
System Up Time	4 hours, 53 mins, 59 secs
Home URL	LevelOne
* LAN	
LAN IP Address	192.168.1.253
LAN Netmask	255.255.255.0
LAN MAC Address	00:04:ED:00:1B:F8
* Wireless LAN	
WLAN Service	Enable
SSID1	wlan-ap
Channel	6
* Power Line	
Power Line Service	Enable
Connected Device	0

Nederlands

Clip Installatie

Installeer de clip van de PLI-3410

1. Volg onderstaand schema om de clip te installeren. (Voorbeeld EU Clip.)

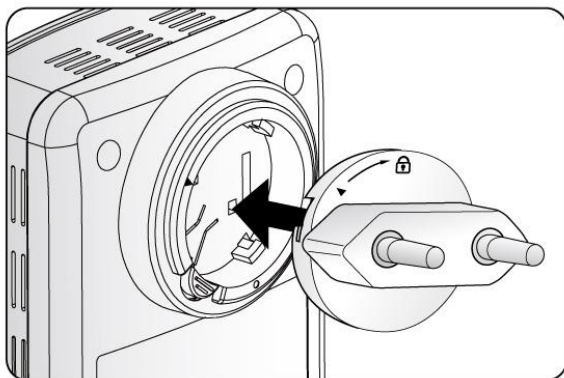

2. Volg de Lock instructie op de clip. Indien u de **“Triangle Lock”** heeft, raadpleeg dan het schema aan de rechter kant.

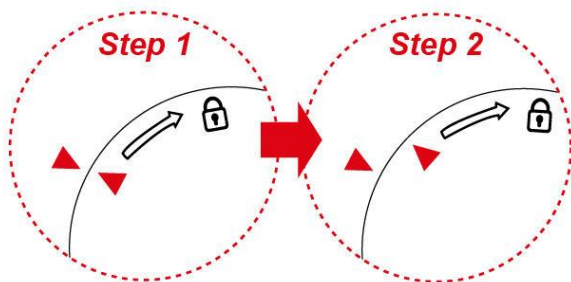
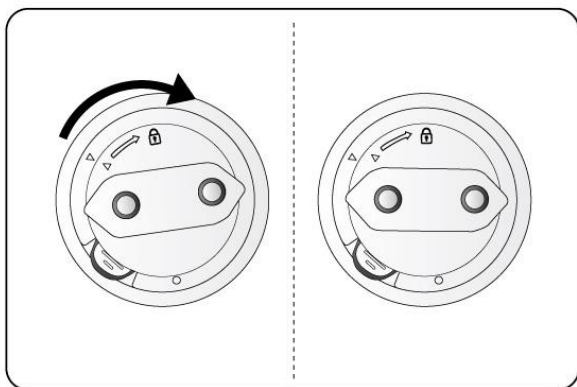

Let op: Het wordt afgeraden om de socket clip frequent te verwijderen of te demonteren. Dit kan tot beschadiging van de A/V Homeplug leiden.

* Voor WPS configuratie raadpleeg de PLI-3410 User Manual voor een uitgebreidere uitleg.

Hardware Installatie

1. Power Connectie

Stop de PLI-3410 in de wandcontactdoos (220V).

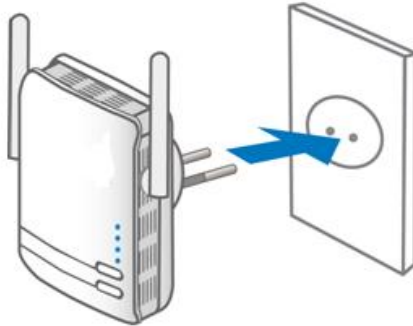

2. LAN & Wireless Connectie

Installatie utility met de LevelOne setup assistent.

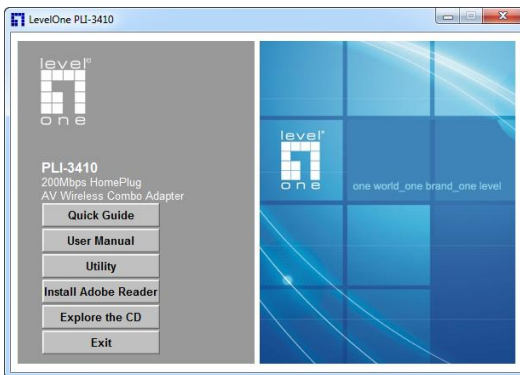

Configuratie via WEB Browser

Start uw WEB browser, voer het IP adres in van de PLI-3410 (standaard **192.168.1.1**), en klik “Go”. U wordt gevraagd om uw gebruikers naam en wachtwoord. Gebruikers account en wachtwoord zijn standaard ingesteld op “admin”.

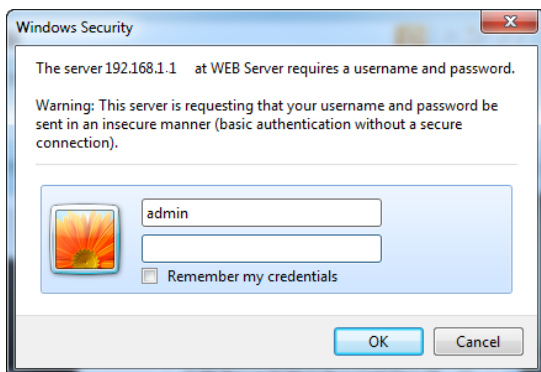

U bent succesvol ingelogd op de PLI-3410 zoals het status venster weergeeft.

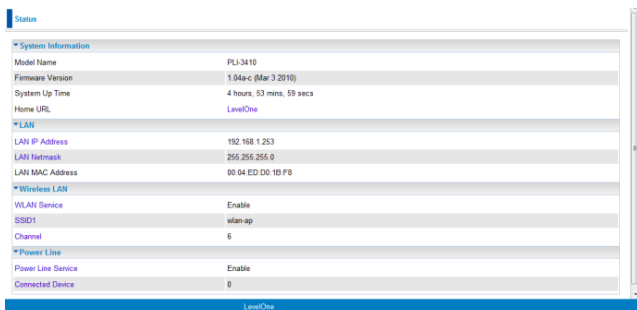

The screenshot shows a web interface for a LevelOne device. The page title is "Status". The content is organized into several sections:

- System Information**
 - Model Name: PLI-3410
 - Firmware Version: 1.04-c (Mar 3 2010)
 - System Up Time: 4 hours, 53 mins, 59 secs
 - Home URL: [LevelOne](#)
- LAN**
 - LAN IP Address: 192.168.1.253
 - LAN Netmask: 255.255.255.0
 - LAN MAC Address: 00.04.ED.D0.1D.F8
- Wireless LAN**
 - WLAN Service: Enable
 - SSID1: wlan-ap
 - Channel: 6
- Power Line**
 - Power Line Service: Enable
 - Connected Device: 0

The LevelOne logo is visible at the bottom of the page.

Clip Installation

Installering af clips med PLI-3410

1. Følg diagram og vejledning for at installere clippen. (Dette er et eksempel på EU clip.)

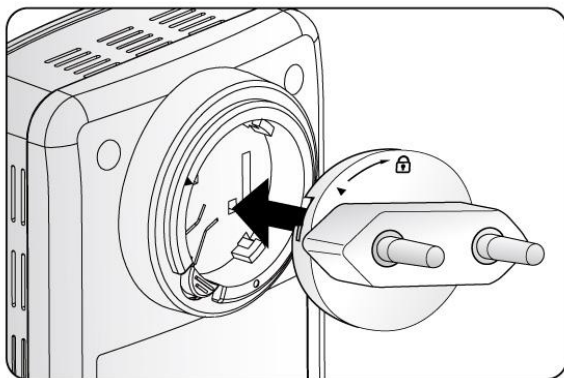

2. Venligst tjek låse instruktionen på din clip. Hvis du har **“Triangle Lock”**, referer til det højre diagram.

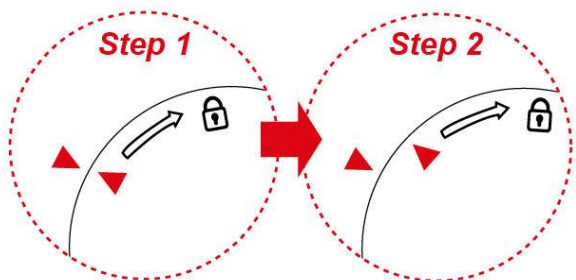
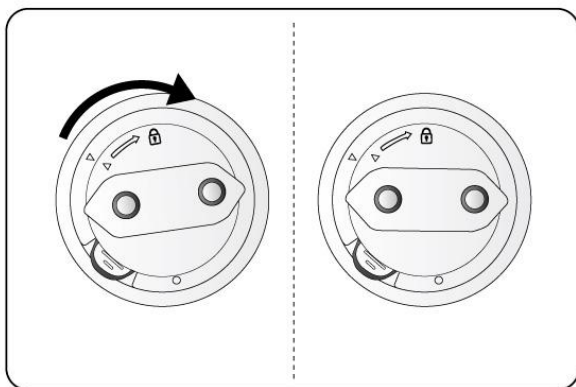

Venligst skild og sammel ikke din socket clip unødvendigt ,
da dette kan give alvorlige skader på din
HomePlug AV enhed.!

*For WPS configuration venligst referer til PLI-3410
bruger manual for mere detaljerede beskrivelser.

Hardware Installation

1. Strøm forbindelse

Indsæt PLI-3410 I væg kontakten

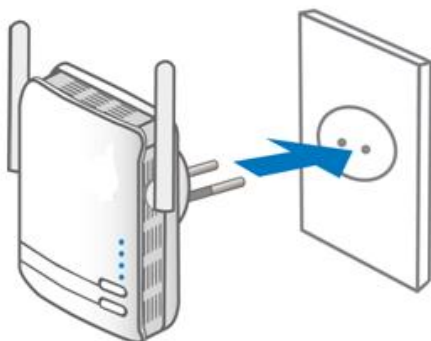

2. LAN & trådløs forbindelse

Installer hjælpeværktøjet med LevelOne setup wizard.

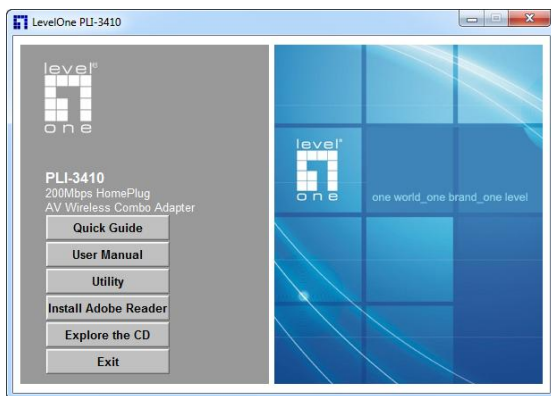

Konfiguration via Web Browser

Åben din web browser, indtast IP adressen på PLI-3410 som fra fabrikken er `http://192.168.1.1`, I din adresse linie og klik **“Go”**. Bruger navn og password vindue vil komme frem. Fabriks brugernavn og password er begge **“admin”**.

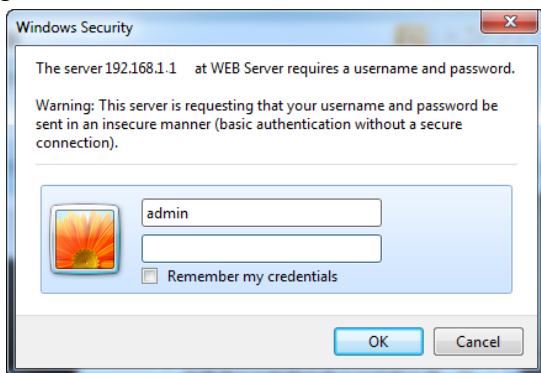

Du er nu succesfuldt logget ind på PLI-3410 når denne status skærm vises.

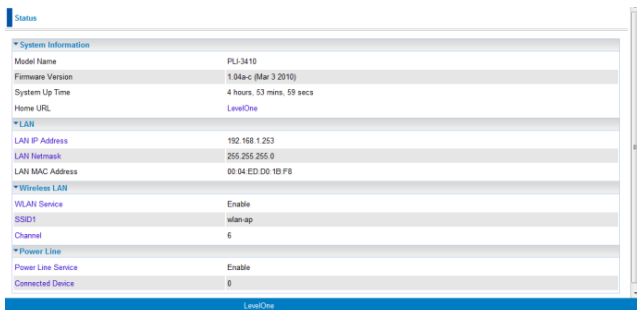

Installazione della clip

Installazione della clip a PLI-3410

1. Seguire l'immagine sottostante e la direzione per installare la clip. (Questo è un esempio per la clip europea.)

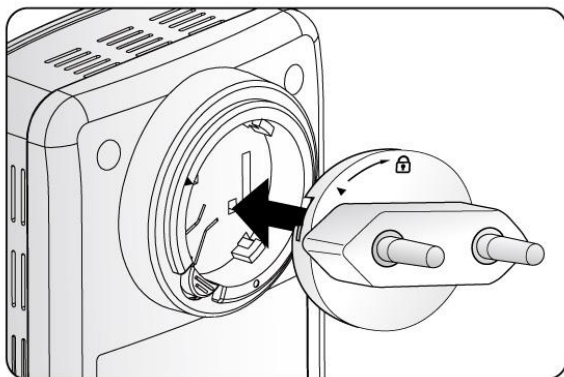

2. Controllare le istruzioni di blocco della clip. Per la “chiusura triangolare” fare riferimento al corretto diagramma.

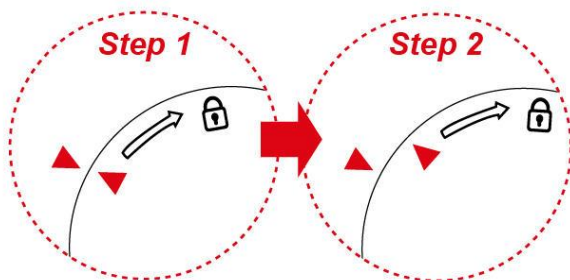
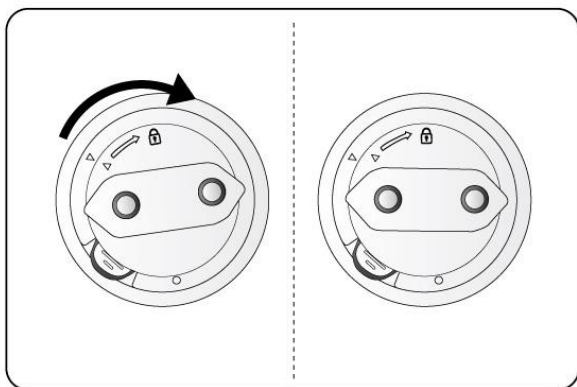

NON rimuovere o disassemblare il supporto della clip frequentemente per evitare di danneggiare il proprio dispositivo HomePlug AV!

*Per la configurazione WPS fare riferimento al manuale utente PLI-3410 per istruzioni.

Installazione Hardware

1. Connessione all'alimentazione

Inserire PLI-3410 nella presa di corrente

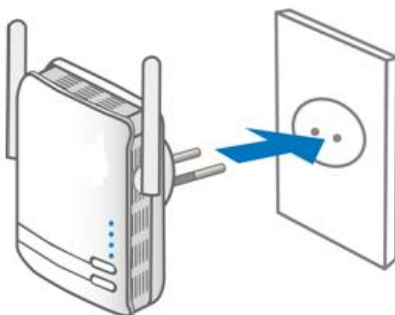

2. Connessione LAN & Wireless

Installare con il software LevelOne setup wizard.

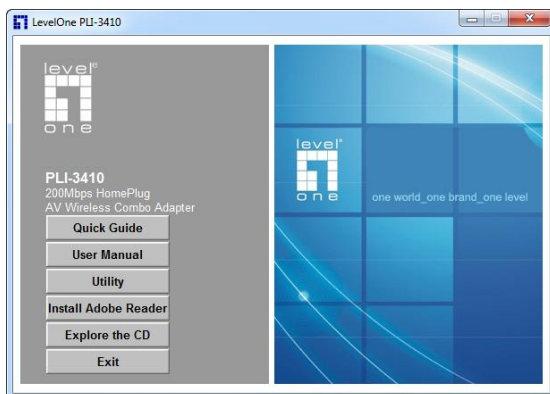

Configurazione da Web Browser

Aprire il web browser, inserire l'indirizzo IP address del PLI-3410 (default è **192.168.1.1**), e cliccare **“Go”**. Successivamente comparirà la finestra di login. Il nome utente e password default sono entrambi **“admin”**.

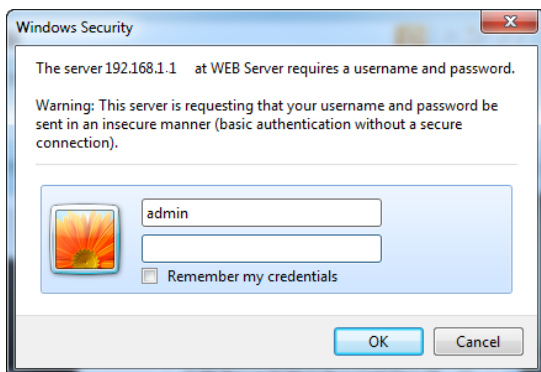

Ora si è loggati con successo al PLI-3410 con la schermata di stato.

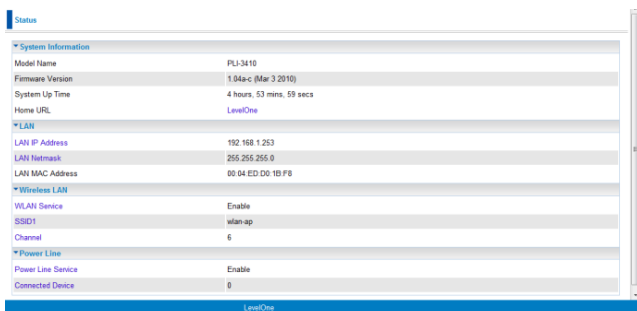
A screenshot of a web interface showing the status of a device. The page has a blue header with the word "Status" in white. Below the header is a table of system information. The table is organized into sections: "System Information", "LAN", "Wireless LAN", and "Power Line". Each section contains several rows of data with labels and values. At the bottom of the page, there is a blue footer with the text "LevelOne".

System Information	
Model Name	PLI-3410
Firmware Version	1.04-c (Mar 3 2010)
System Up Time	4 hours, 53 mins, 59 secs
Home URL	LevelOne
LAN	
LAN IP Address	192.168.1.253
LAN Netmask	255.255.255.0
LAN MAC Address	00:04:ED:D6:1B:F8
Wireless LAN	
WLAN Service	Enable
SSID1	wlan-ap
Channel	6
Power Line	
Power Line Service	Enable
Connected Device	0

Τοποθέτηση βύσματος

Τοποθέτηση βύσματος στο PLI-3410

1. Ακολουθήστε τα διαγράμματα και την φορά για την εγκατάσταση του βύσματος. (Αυτό το παράδειγμα αφορά το ευρωπαϊκό (EU) βύσμα.)

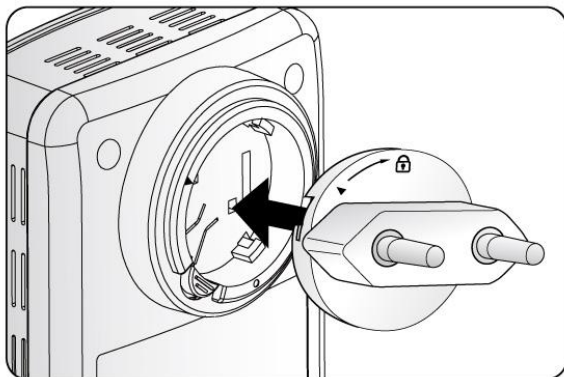

2. Παρακαλώ ελέγξτε τις οδηγίες κλειδώματος πάνω στο βύσμα σας. Εάν διαθέτετε το **“Τριγωνικό Κλείδωμα”**, παρακαλώ ανατρέξτε στο σωστό διάγραμμα.

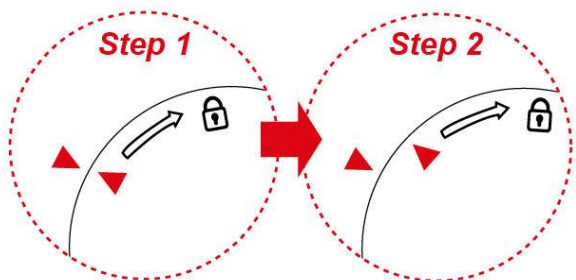
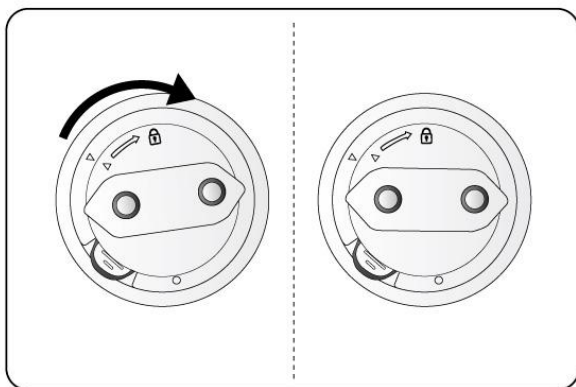

Παρακαλώ ΜΗΝ αφαιρείτε ή αποσυναρμολογείτε το βύσμα της πρίζας συχνά. Αυτό μπορεί να δημιουργήσει σοβαρή βλάβη στην Home Plug AV συσκευή σας!

* Για την WPS παραμετροποίηση παρακαλώ ανατρέξτε στο εγχειρίδιο της χρήσης του PLI-3410 για πιο αναλυτική περιγραφή.

Εγκατάσταση υλικού

1. Σύνδεση στην πρίζα

Συνδέστε το PLI-3410 στην πρίζα/έξοδο στον τοίχο.

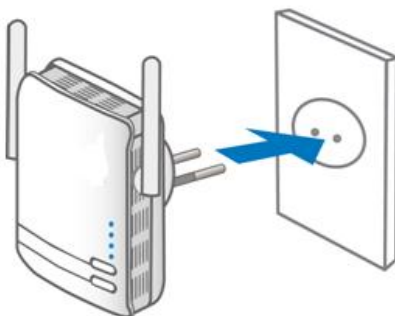

2. LAN & Ασύρματη Σύνδεση

Εγκαταστήστε την εφαρμογή χρησιμοποιώντας τον οδηγό εγκατάστασης της LevelOne.

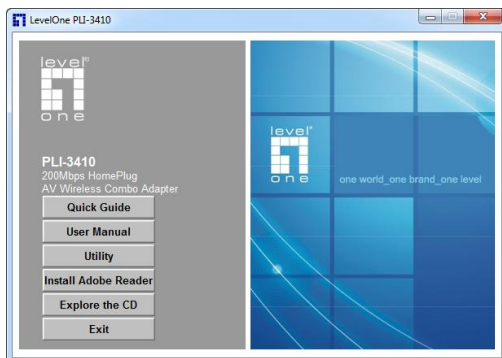

Παραμετροποίηση μέσω Web Browser

Εκκινήστε ένα Web Browser, και εισάγετε στο πεδίο εισαγωγής διεύθυνσης την διεύθυνση IP του PLI-3410. Η εργοστασιακή IP διεύθυνση είναι **192.168.1.1**, επιλέξτε **“Go”**. Το παράθυρο πιστοποίησης χρήστη θα εμφανιστεί. Το εργοστασιακό όνομα χρήστη και ο κωδικός πρόσβασης είναι και τα δύο **“admin”**.

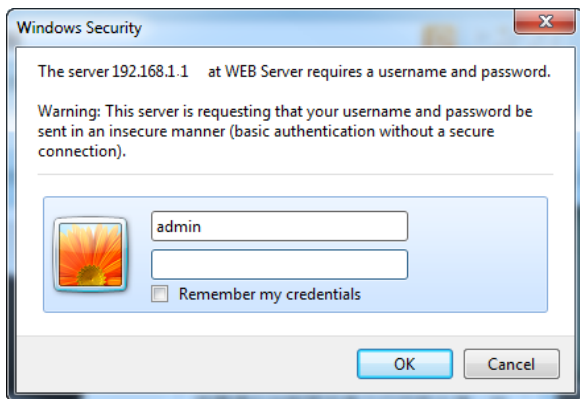

Έχετε πλέον συνδεθεί με το PLI-3410 με επιτυχία. Η οθόνη “Status” θα πρέπει να εμφανίζεται.

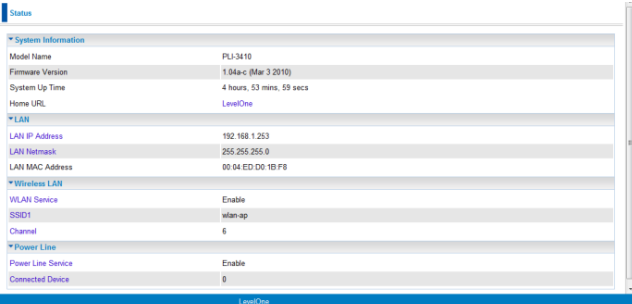

System Information	
Model Name	PLI-3410
Firmware Version	1.04a-c (Mar 3 2010)
System Up Time	4 hours, 53 mins, 59 secs
Home URL	LevelOne
LAN	
LAN IP Address	192.168.1.253
LAN Netmask	255.255.255.0
LAN MAC Address	00:04:ED:D0:1B:F8
Wireless LAN	
WLAN Service	Enable
SSID1	wlan-ap
Channel	6
Power Line	
Power Line Service	Enable
Connected Device	0

LevelOne

Instalação da braçadeira

Instalando a braçadeira com PLI-3410

1. Siga os diagramas e direções para instalar a braçadeira. (Este é um exemplo da braçadeira da UE.)

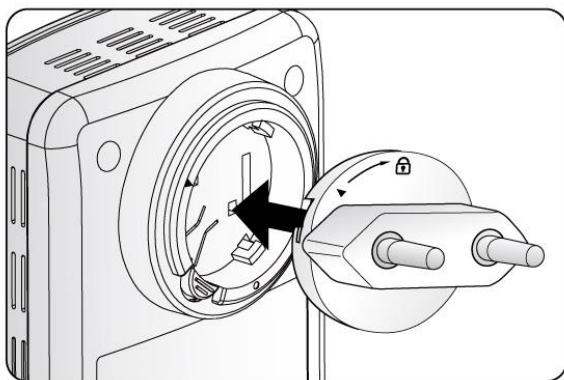

2. Favor verificar as instruções de travamento em sua braçadeira. Caso você tenha a **“Trava triângulo”**, consulte o diagrama à direita.

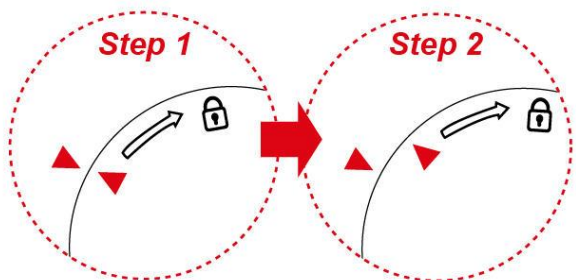
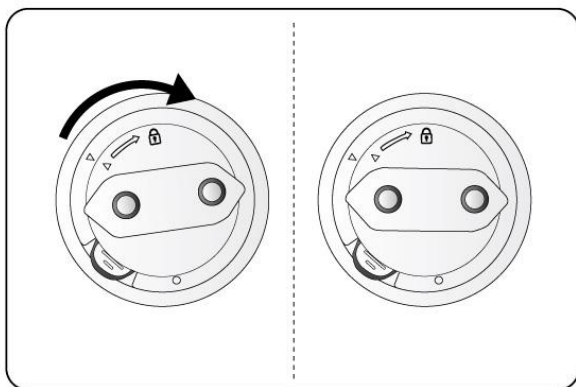

Por favor, NÃO remova nem desmonte a braçadeira de soquete frequentemente uma vês que isto pode causar sérios danos ao seu equipamento AV HomePlug!

*Para configuração WPS favor consultar o Manual do usuário PLI-3410 para mais descrições detalhadas.

Instalação do hardware

1. Conexão de energia

Plugue o PLI-3410 na saída/tomada da parede

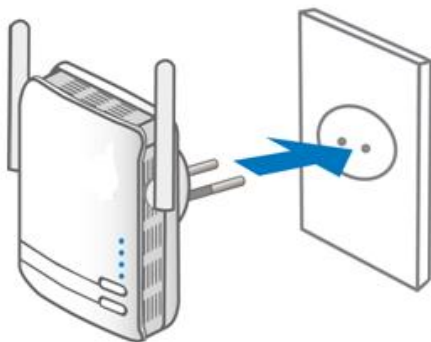

2. Conexão LAN e sem fio

Instale o utilitário com o assistente de configuração LevelOne.

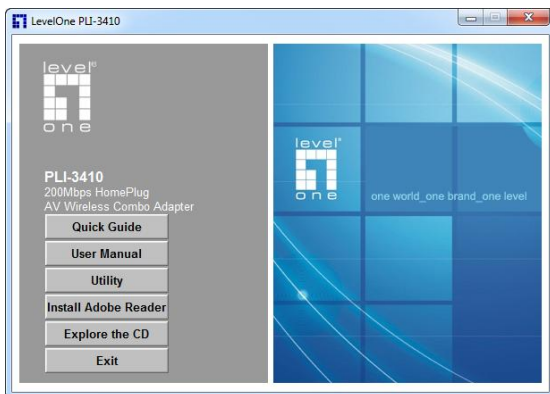

Configurando o navegador de internet

Abra seu navegador de internet, digite o endereço de IP do PLI-3410 que por padrão é **192.168.1.1**, e clique que **“Go”** (Ir). A janela de nome do usuário e senha aparecerá. O nome de usuário e senha padrão são ambos **“admin”**.

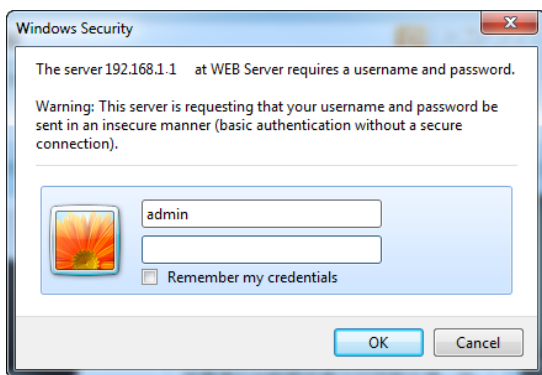

Você está agora logado com sucesso ao PLI-3410 quando a tela de Status aparecer.

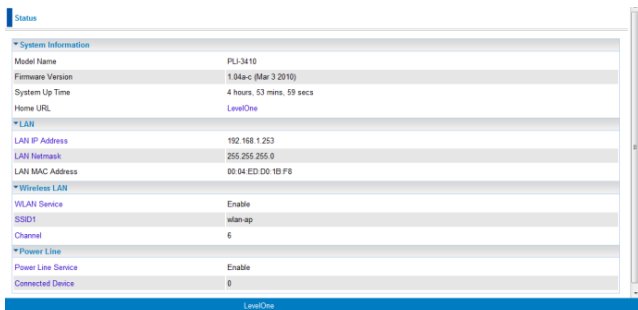

System Information	
Model Name	PLI-3410
Firmware Version	1.04a-c (Mar 3 2010)
System Up Time	4 hours, 53 mins, 59 secs
Home URL	LevelOne
LAN	
LAN IP Address	192.168.1.253
LAN Netmask	255.255.255.0
LAN MAC Address	00:04:ED:D0:1D:F8
Wireless LAN	
WLAN Service	Enable
SSID1	wlan-ap
Channel	6
Power Line	
Power Line Service	Enable
Connected Device	0

Montering av stickpropp

Montera stickproppen på PLI-3410

1. Följ nedanstående bilder och anvisningar när du monterar stickproppen.

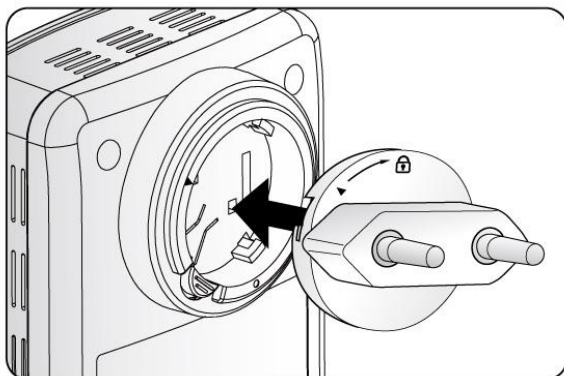

2. Följ märkningen på stickproppen och enheten enligt bilden. Vrid stickproppen på plats.

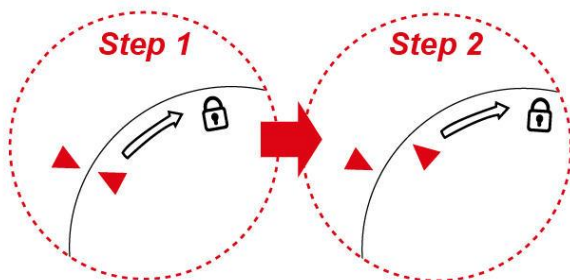
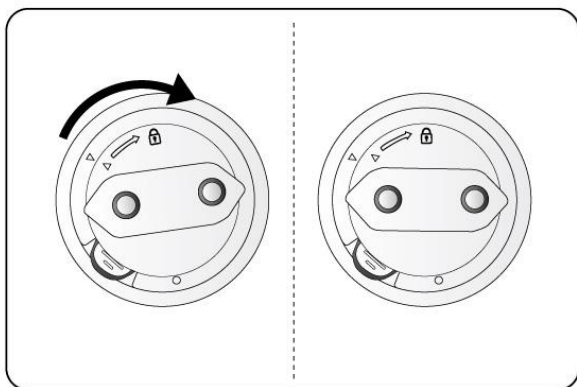

Stickproppen får absolut inte monteras isär och ska inte tas av och sättas på i onödan! Din HomePlug AV enhet kan skadas allvarligt av upprepade monteringar!

*För WPS konfigurering var god se PLI-3410 'User Manual' för detaljerade anvisningar..

Hårdvaruinstallation

1. Anslut till elnätet

Sätt in PLI-3410 I ett vägguttag

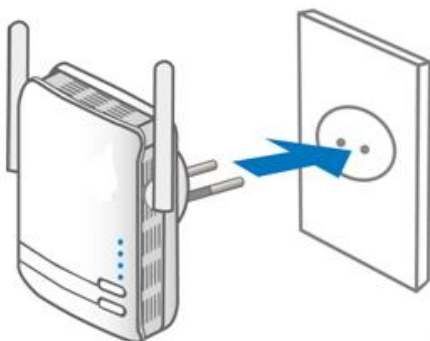

2. LAN & Trådlös Förbindelse

Installera 'Utility' med LevelOne setup wizard.

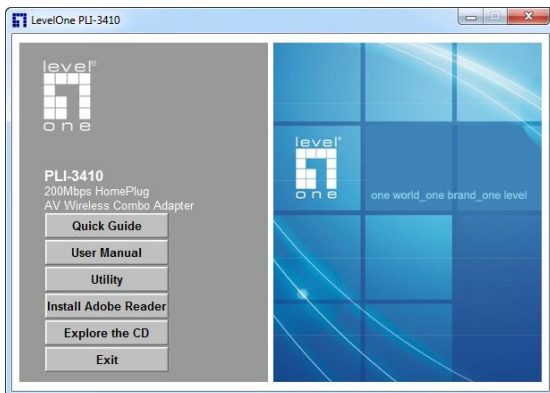

Konfigurering med Webbläsare

Öppna Webbläsaren och ange IP adressen för PLI-3410. Från fabrik är den **192.168.1.1**. Din dator måste ha en IP-adress i samma subnät, ex. 192.168.1.2. Ett inloggningsfönster kräver användare, user och lösenord, password. Båda är **“admin”**.

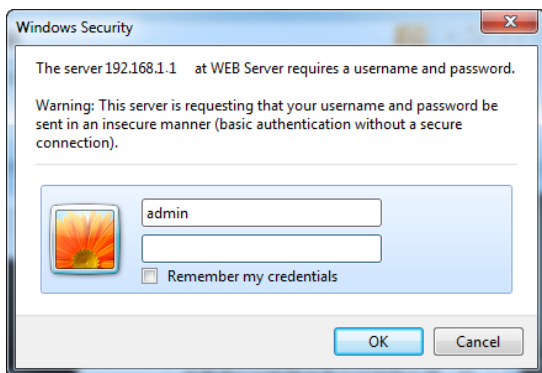

När statussidan visa är du inloggad på PLI-3410.

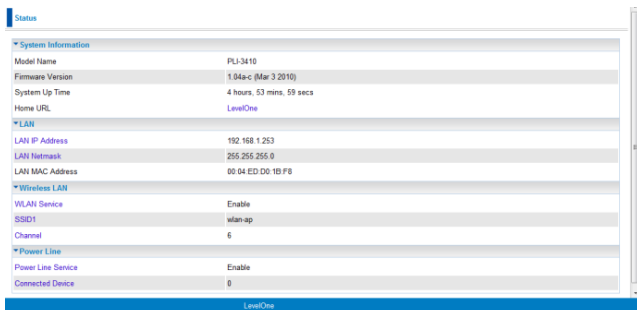
A screenshot of the status page for a PLI-3410 device. The page is titled "Status" and has a blue header. The content is organized into sections with expandable/collapsible icons. The sections and their details are:

- System Information**
 - Model Name: PLI-3410
 - Firmware Version: 1.04a-c (Mar 3 2010)
 - System Up Time: 4 hours, 53 mins, 59 secs
 - Home URL: [LevelOne](#)
- LAN**
 - LAN IP Address: 192.168.1.253
 - LAN Netmask: 255.255.255.0
 - LAN MAC Address: 00:04:ED:D0:1D:F8
- Wireless LAN**
 - WLAN Service: Enable
 - SSID1: wlan-ap
 - Channel: 6
- Power Line**
 - Power Line Service: Enable
 - Connected Device: 0

The "LevelOne" logo is visible at the bottom of the page.

Namestitev vtiča

Namestitev vtiča v PLI-3410

1. Sledite slikovnim navodilom za pravilno namestitev električnega vtiča v napravo.
(To je primer za EU vtič.)

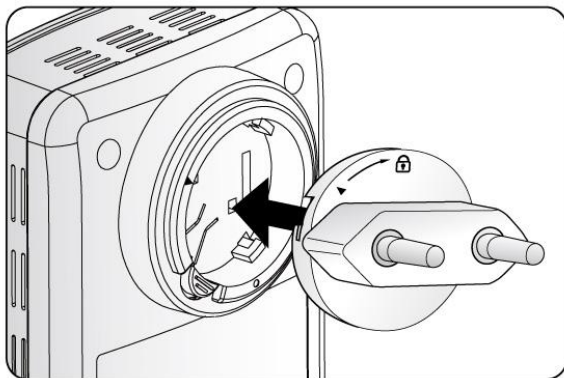

2. Prosimo preverite navodila na vašem vtiču
Če imate **“Triangle Lock(trikotni zaklep)”**,
glejte ustrezni diagram.

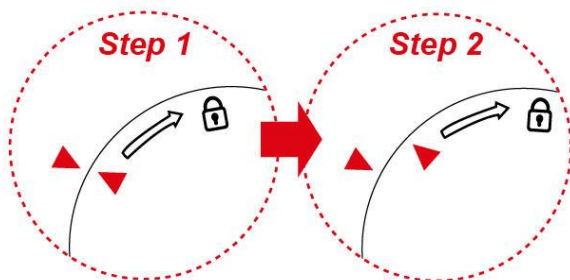
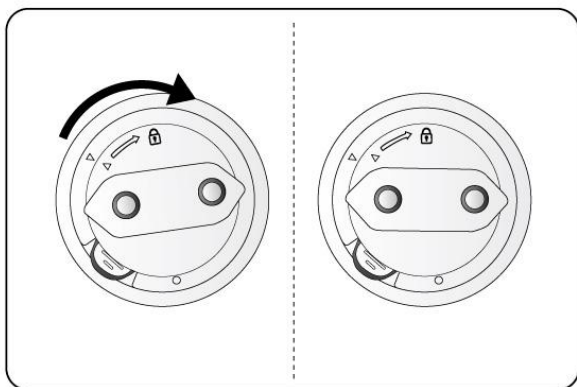

Prosimo ne odstranite ali razstavljajte vtiča prepogosto, ker lahko povzroči napako na vaši napravi!

*Za nastavitve WPS (kodiranje brezžične povezave) si oglejte priložena razširjena navodila za uporabo.

Namestitev naprave

1. Napajanje

Vključite PLI-3410 v električno vtičnico.

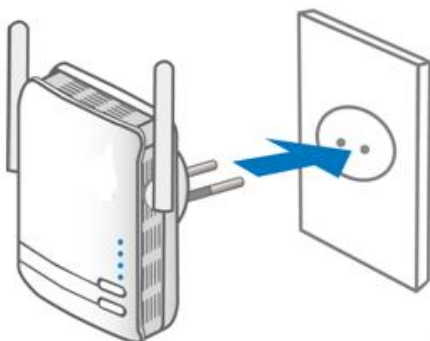

2. LAN & Brezžična povezava

Namestite priloženo programsko opremo s čarovnikom za hitro namestitev.

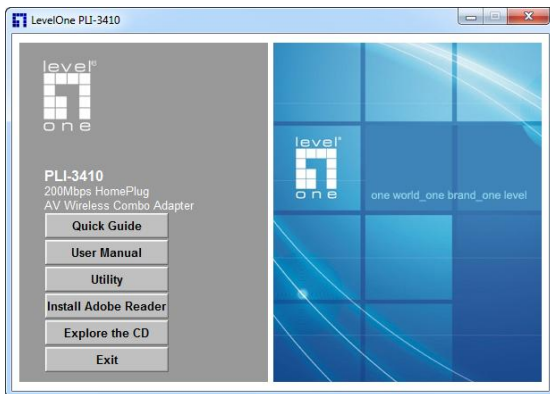

Namestitev preko spletnega brskalnika

Odprite spletni brskalnik, vnesite IP naslov **192.168.1.1** . Pojavilo se bo okence za vnos uporabniškega imena in gesla. V obe polji vnesite **“admin”**.

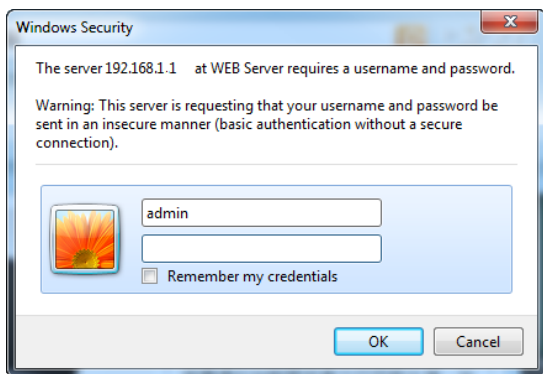

Sedaj ste uspešno prijavljeni v PLI-3410 in lahko vidite statusno stran naprave.

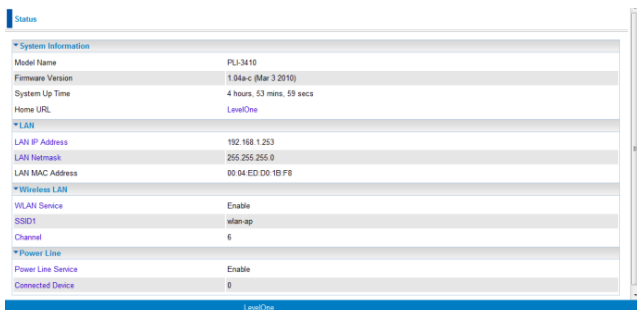

Status	
System Information	
Model Name	PLI-3410
Firmware Version	1.04a-c (Mar 3 2010)
System Up Time	4 hours, 53 mins, 59 secs
Home URL	LevelOne
LAN	
LAN IP Address	192.168.1.253
LAN Netmask	255.255.255.0
LAN MAC Address	00:04:ED:D0:1B:F8
Wireless LAN	
WLAN Service	Enable
SSID	wlan-ap
Channel	6
Power Line	
Power Line Service	Enable
Connected Device	0

Установка съемной штепсельной вилки

Установка съемной штепсельной вилки для адаптера PLI-3410

1. Установите съемную штепсельную вилку согласно иллюстрациям, соблюдая указанное направление. (На иллюстрации показан пример вилки европейского типа.)

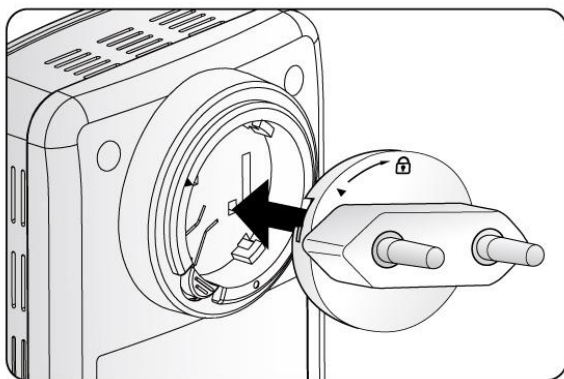

2. Ознакомьтесь с инструкцией к замку на используемой съемной штепсельной вилке. Если она оснащена **«замком символами треугольников»**, следуйте указаниям на иллюстрации справа.

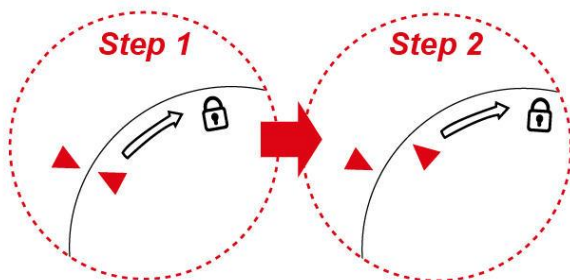
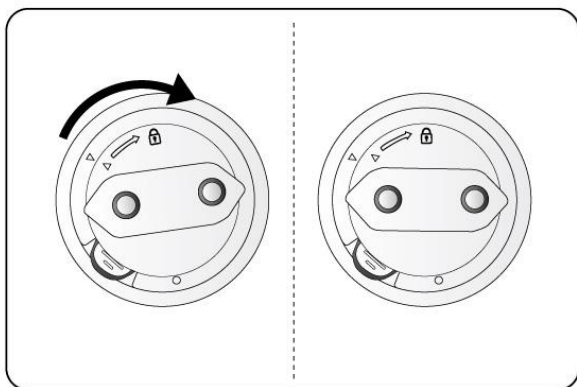

НЕ СЛЕДУЕТ часто снимать и разбирать съемную
штепсельную вилку, так как это может привести к
серьезному повреждению адаптера HomePlug AV!

* Подробные сведения о конфигурации WPS см. в
Руководстве пользователя адаптера PLI-3410.

Установка оборудования

1. Подключение питания

Подсоедините адаптер PLI-3410 к настенной электрической розетке.

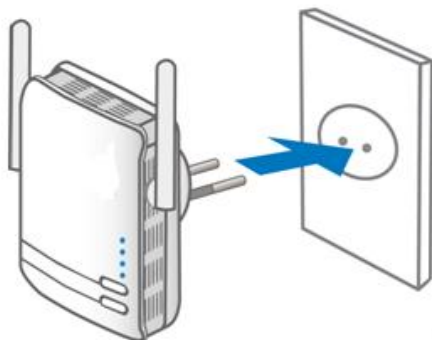

2. Подключение к ЛВС и беспроводной сети

Установите служебную программу с помощью мастера установки LevelOne.

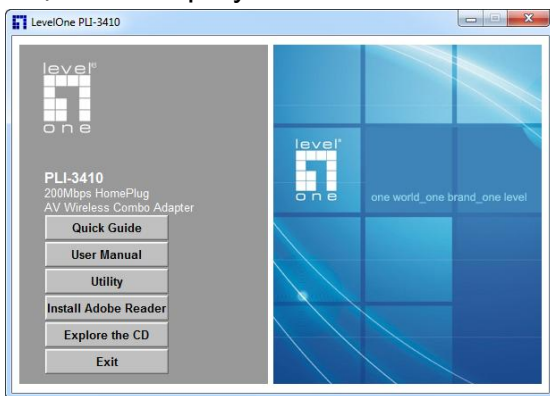

Настройка с помощью веб-браузера

В адресной строке веб-браузера введите IP-адрес адаптера PLI-3410 (по умолчанию используется адрес **192.168.1.1**) и нажмите кнопку «**Go**» (**Переход**). Отобразится окно с запросом имени пользователя и пароля. По умолчанию в качестве как пароля, так и имени пользователя используется «**admin**».

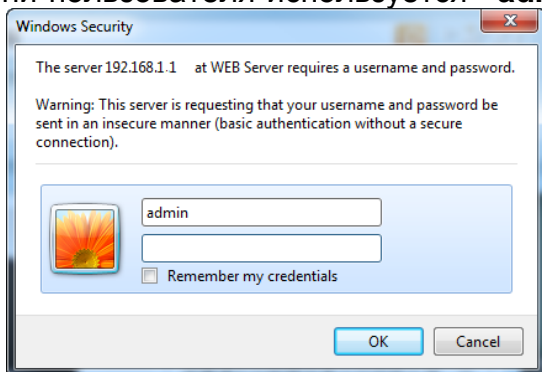

После этого будет выполнен вход в систему адаптера PLI-3410, и отобразится страница Status (Состояние).

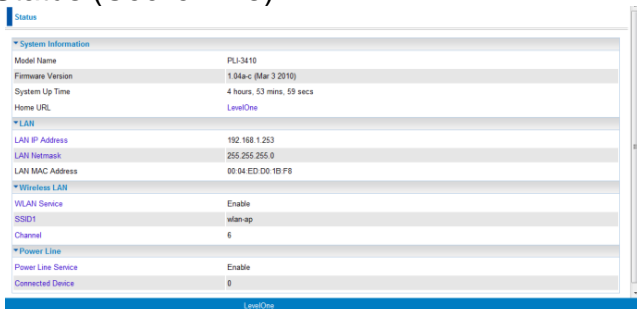

Zamocowanie wtyku

Mocowanie wtyku do PLI-3410

1. Proszę włożyć wtyk do obudowy tak jak na obrazku. (Na obrazku podano przykład wtyku z dwoma bolcami.)

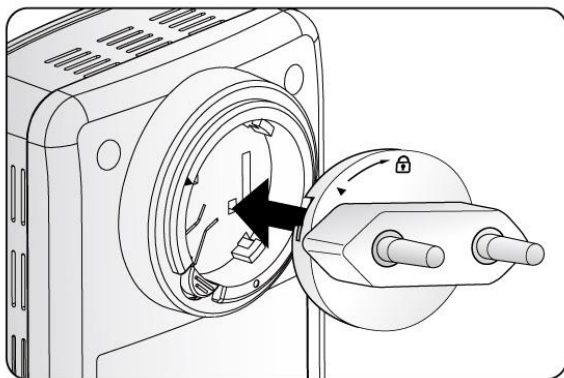

2. Proszę sprawdzić żeby przy wkładaniu wtyku zaznaczone trójkąty były w tej samej pozycji. Po włożeniu, przekręcić w prawo.

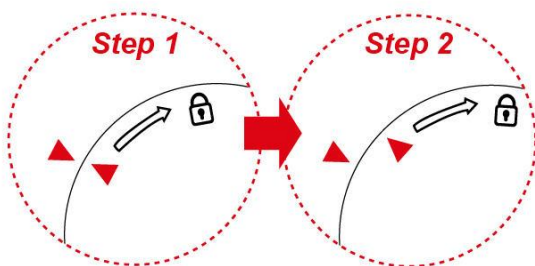
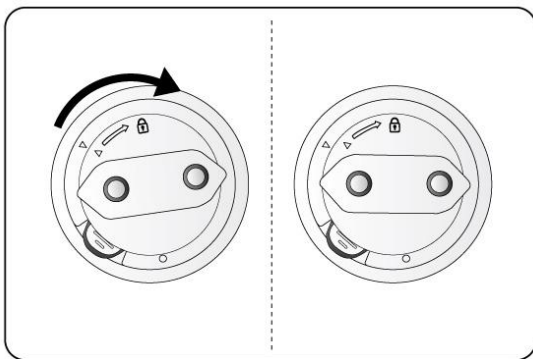

Proszę NIE wyjmować i wkładać wtyku wielokrotnie.
Wielokrotne wyjmowanie wtyku może doprowadzić do
poważnego uszkodzenia całego urządzenia HomePlug AV!

*Przy instalacji WPS proszę przeczytać dokładny opis
procedury w Instrukcji użytkownika dla urządzenia PLI-
3410 (User Manual).

Instalacja urządzenia

1. Podłączenie do zasilania

Proszę włożyć PLI-3410 do gniazda z prądem na 230V bezpośrednio na ścianie.

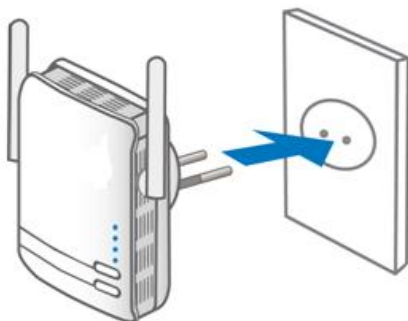

2. Podłączenie sieci lokalnej typu LAN & Wireless

Zainstalowanie poprzez instalator LevelOne (Setup wizard).

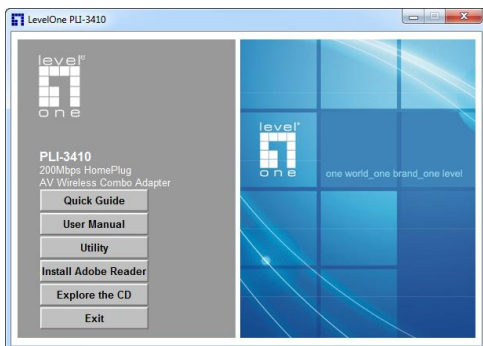

Konfiguracja poprzez przeglądarkę stron www

Otwórz przeglądarkę, podaj IP adres dla twojego PLI-3410 który fabrycznie jest ustawiony na **192.168.1.1**, naciśnij **“Go”**. Na ekranie pokaże się nazwa użytkownika i hasło. Fabryczne ustawienia dla obydwóch parametrów jest **“admin”**. Wpisz dwa razy słowo admin i naciśnij **“OK”**.

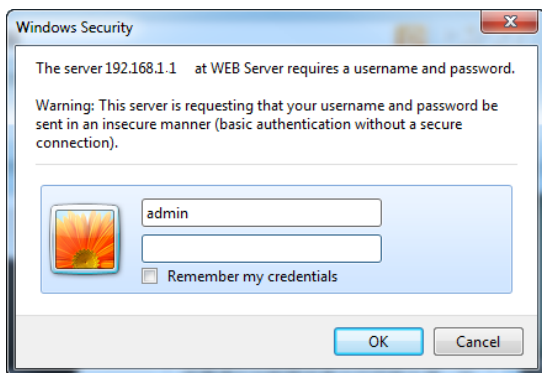

Jesteś prawidłowo zalogowany do PLI-3410 jeśli na ekranie pokaże się strona statusowa jak poniżej.

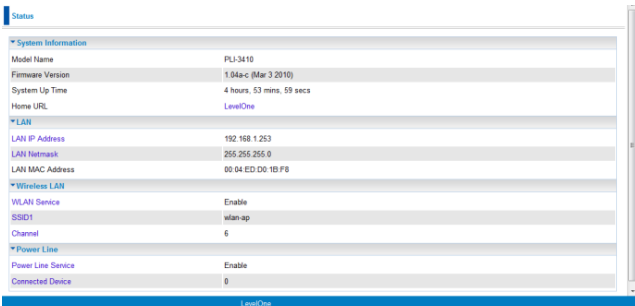

Status

System Information	
Model Name	PLI-3410
Firmware Version	1.04a-c (Mar 3 2010)
System Up Time	4 hours, 53 mins, 59 secs
Home URL	LevelOne
LAN	
LAN IP Address	192.168.1.253
LAN Netmask	255.255.255.0
LAN MAC Address	00:04:ED:D0:1B:F8
Wireless LAN	
WLAN Service	Enable
SSID1	wlan-ap
Channel	6
Power Line	
Power Line Service	Enable
Connected Device	0

LevelOne