



HDSpider™ HDMI over Single Cat.5 Distribution Series

HVE-9000

HVE-9001

HVE-9002

HVE-9003

HVE-9900

User Manual

TABLE OF CONTENT

p.2	Package Content
p.3	Product Introduction
p.4	Panel Description
p.7	Installation
p.12	Systematic Application Diagrams
p.13	Frequently Asked Questions
p.14	Specifications
p.15	Notice

Package Content

HVE-9000 HDSpider™ HDMI Cat.5 Receiver (Long)

1. HDSpider™ HDMI Cat.5 Receiver (Long) (HVE-9000)
2. 5V 2A DC Adapter
3. User Manual



HVE-9001 HDSpider™ HDMI Cat.5 Sender

1. HDSpider™ HDMI Cat.5 Sender (HVE-9001)
2. 5V 2A DC Adapter
3. User Manual



HVE-9002 HDSpider™ HDMI Cat.5 Sender + 1 HDMI Out

1. HDSpider™ HDMI Cat.5 Sender + 1 HDMI Out (HVE-9002)
2. 5V 4A DC Adapter
3. User Manual



HVE-9003 HDSpider™ HDMI Cat.5 Sender (Cascadable)

1. HDSpider™ HDMI Cat.5 Sender (Cascadable) (HVE-9003)
2. 5V 4A DC Adapter
3. User Manual



HVE-9900 HDSpider™ HDMI Cat.5 Receiver (Short)

1. HDSpider™ HDMI Cat.5 Receiver (Short) (HVE-9900)
2. User Manual



Product Introduction

Introduction

The HDSpider™ HDMI over Single Cat.5 Distribution Series provides the most flexible solution by which the uncompressed, unmodified, and pure digital HDMI signals with 7.1-channel audio can be transmitted to different locations over a long distance. The cascading of HDSpider™ series is virtually unlimited, allowing you to extend HDMI/DVI displays almost anywhere.

The whole HDSpider™ series products can be easily inter-connected to suit almost every application through Cat.5/5e/6 cables. By taking the advantage of Cat.5/5e/6 cables, installation work becomes so easy and particularly cost effective wherever the distribution of HDMI signals is required.

Features

The HDSpider™ HDMI over Single Cat.5 Distribution Series offers the users:

- ✧ HDMI signal transmission through Cat.5/5e/6 cables
- ✧ Cat.5/5e/6 cable implementation to minimize use of high-cost HDMI cable
- ✧ Minimum 40m extension for 1080p resolution*
- ✧ Maximum extension up to 80m**
- ✧ Uncompressed, unmodified HDMI with 7.1-channel audio/video pure digital transmission
- ✧ Cascading virtually unlimited for HVE-9003
- ✧ Compliant with HDMI 1.2
- ✧ Build in 8-level equalizer to fine tune video quality
- ✧ EDID learning ability to read and store the EDID information of the display to avoid any incompatibility among displays
- ✧ Software not required, purely hardware installation. Virus risk free

Note: The length depends on the characteristics and quality of the cables. Higher resolutions and longer transmission distances require low skew cables (<25ns/100m) for best performance.

*single link of HVE-9000. For connection with HVE-9900, 1080p distance at minimum 15m.

**single link at 480p resolution, with high quality, minimal delay skew Cat-6 cable

Panel Description

HVE-9000 HDSpider™ HDMI Cat.5 Receiver (Long)

Front View

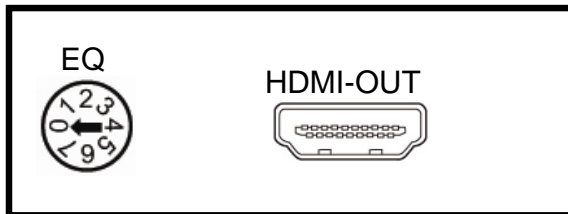

HDMI OUT: Connect to a HDMI display with a HDMI M-M cable here.

EQ: Adjust the 8-level equalization control knob to the received HDMI signals. 0 - 7 = strongest – weakest. It is recommended to adjust from 7 to 0 to find the optimal visual experience.

Rear View

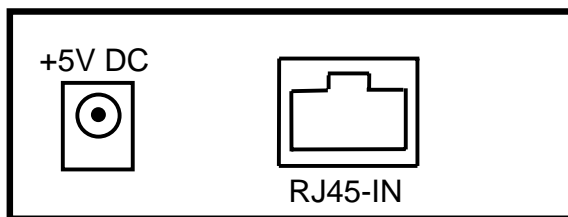

RJ45-IN: Plug in a Cat. 5e/6 cable that needs to be linked to the RJ-45 connector of the HVE-9000.

+5V DC: Connect to 5V 2A DC power supply.

HVE-9001 HDSpider™ HDMI Cat.5 Sender

Front View

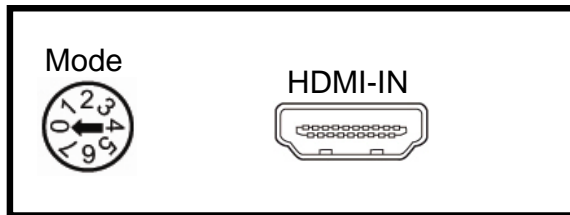

HDMI IN: Connect a HDMI source with a HDMI M-M cable here

Mode: 0 = HDMI mode with 8-channel audio
1 = HDMI mode with 2-channel audio
2-5 = Reserved
6 = Use default EDID (indicated by the RJ-45 LED)
7 = Learn EDID from the display (indicated by the RJ-45 LED)

Note

1. Don't plug in HDMI cable to HDMI input connector while processing writing default EDID or writing monitor EDID.
2. The LED next to the rotary control knob turns off when the writing process is completed.
3. The HVE-9001 reads the EDID information from the HDMI socket of the connected HDTV, so please connect the display from which you want to read EDID to **HDMI-OUT** of the HVE-9000.

Rear View

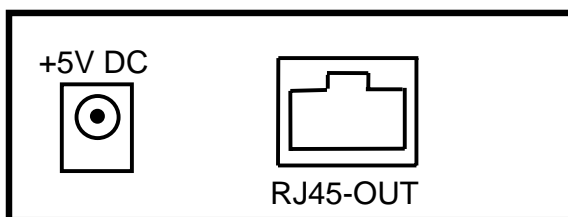

RJ45-OUT: Plug in a Cat.5e/6 cable that needs to be linked to the RJ45 connector of the HVE-9000 or HVE-9900.

+5V DC: Connect to 5V 2A DC power supply.

HVE-9002 HDSpider™ HDMI Cat.5 Sender + 1 HDMI Out

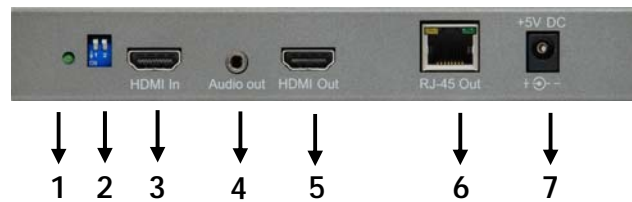

1. Power indicator
2. DIP switch: 1=OFF: Use default EDID;
1=ON: Learn EDID from the display;
2=OFF: HDMI with 8-channel audio mode;
2=ON: HDMI with 2-channel audio mode
3. **HDMI In:** Connect a HDMI source with a HDMI M-M cable here
4. **Audio out:** Plug in a local speaker here
5. **HDMI Out:** Connect to a HDMI display with a HDMI M-M cable here
6. **RJ-45 Out:** Link to HVE-9003 for cascading; or link to HVE-9000 or HVE-9900 to another HDMI display with a Cat.5e/6 cable
7. **+5V DC:** Connect to 5V 4A DC power supply

Note

1. Don't plug in HDMI cable to **HDMI In** while processing writing default EDID or writing display EDID.
2. The LED next to the rotary control knob turns off when the writing process is completed.
3. The HVE-9002 reads the EDID information from the HDMI socket of the connected HDTV, so please connect the display from which you want to read EDID to **HDMI Out**.

HVE-9003 HDSpider™ HDMI Cat.5 Sender (Cascadable)

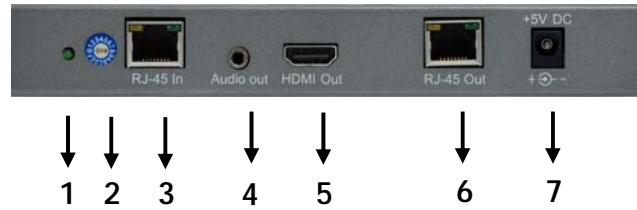

1. Power indicator
2. 16-level rotary control knob: Adjust the 16-level equalization control knob according to the transmission distance of receiving HDMI signals. For 5.1/7.1-channel mode audio output, please adjust from 0 to 7 (longest-to-shortest transmission distance). For stereo mode audio output, please adjust from 8 to F (longest-to-shortest transmission distance). It is recommended to adjust from 7 to 0 or from F to 8 to find the optimal visual experience.
3. **RJ-45 In:** Link to HVE-9001, HVE-9002, or HVE-9003 with a CAT.5e/6 cable
4. **Audio out:** Plug in a local speaker here
5. **HDMI Out:** Connect to a HDMI display with a HDMI M-M cable here
6. **RJ-45 Out:** Link to another HVE-9003 for cascading; or link to HVE-9000 or HVE-9900 to another HDMI display with a Cat.5e/6 cable
7. **+5V DC:** Connect to 5V 4A DC power supply

HVE-9900 HDSpider™ HDMI Cat.5 Receiver (Short)



RJ-45 socket: Link from HVE9001, HVE-9002, HVE-9003, or HVE-9900 with a Cat.5e/6 cable

HDMI socket: Connect to a local HDMI display, or the HDMI output of HVE-9002 or HVE-9003 for HDMI over Cat.5 transmission

Installation

Extends HDMI signals to one display at longer distance

HVE-9000 & HVE-9001

1. Connect HVE-9001 to your HDMI source (such as a Blu-ray Disc player) through a HDMI cable.
2. Connect HVE-9000 to your HDMI display (such as a LCD TV) through a HDMI cable.
3. Connect your CAT-5/5e/6 cable between HVE-9000 and HVE-9001.
4. Make sure your CAT-5/5e/6 cable is tightly connected and not loose.
5. Plug in 5V DC power cord to the power jack of HVE-9000.
6. Plug in 5V DC power cord to the power jack of HVE-9001.
7. *If a flickering or a blinking image is seen, try to adjust the rotary control knob to improve the cable skew. 0 stands for the strongest EQ while 7 stands for the weakest. Try adjusting the EQ from 7 to 0.*

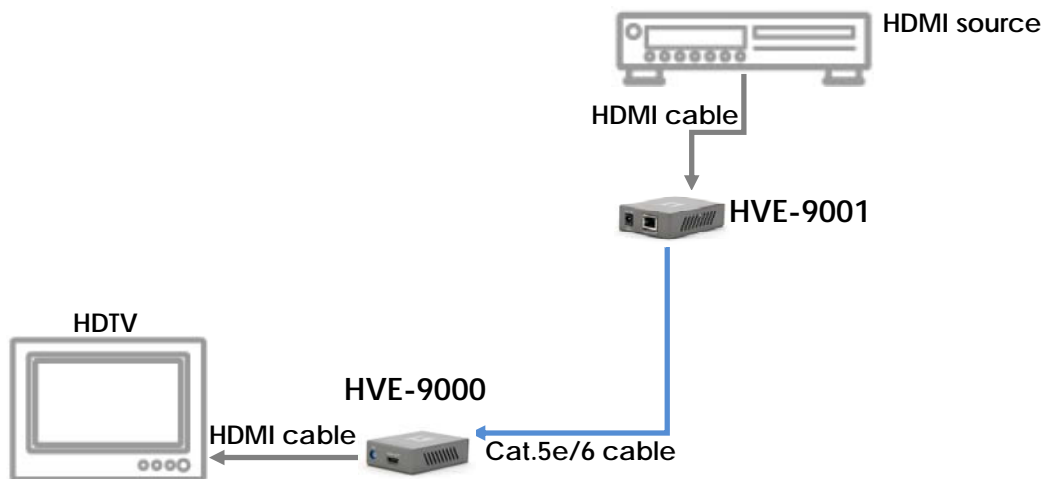

Extends HDMI signals to one display at shorter distance

HVE-9900 & HVE-9001

1. Connect HVE-9001 to your HDMI source (such as a Blu-ray Disc player) through a HDMI cable.
2. Connect HVE-9900 directly to your HDMI display (such as a LCD TV).
3. Connect your CAT-5/5e/6 cable between HVE-9001 and HVE-9900.
4. Make sure your CAT-5/5e/6 cable is tightly connected and not loose.
5. Plug in 5V DC power cord to the power jack of HVE-9001.

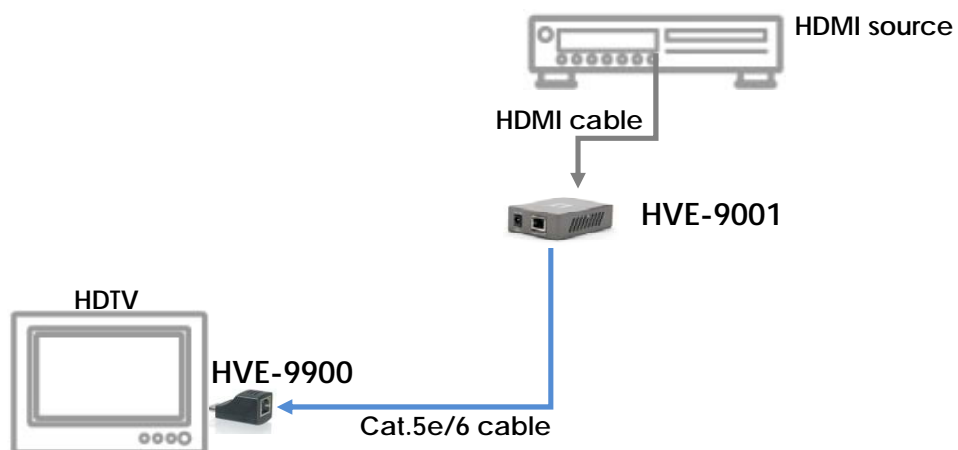

Extends HDMI signals to next cascading device with one local display

HVE-9002

1. Switch off all devices, including monitors.
2. Connect a local HDMI display to the HDMI out of the HVE-9002 and then connect a speaker to the 3.5mm audio socket.
3. Connect to a HDMI source (such as a Blu-Ray Disc player)
4. Connect HVE-9002 to HVE-9003 (for cascading), to HVE-9000 (to HDTV at long range), or HVE-9900 (to HDTV at mid range) via RJ-45 Out by a Cat.5e cable.
5. Plug in 5V4A DC power supply.
6. Power on the HDTV.
7. Power on the HDMI source.

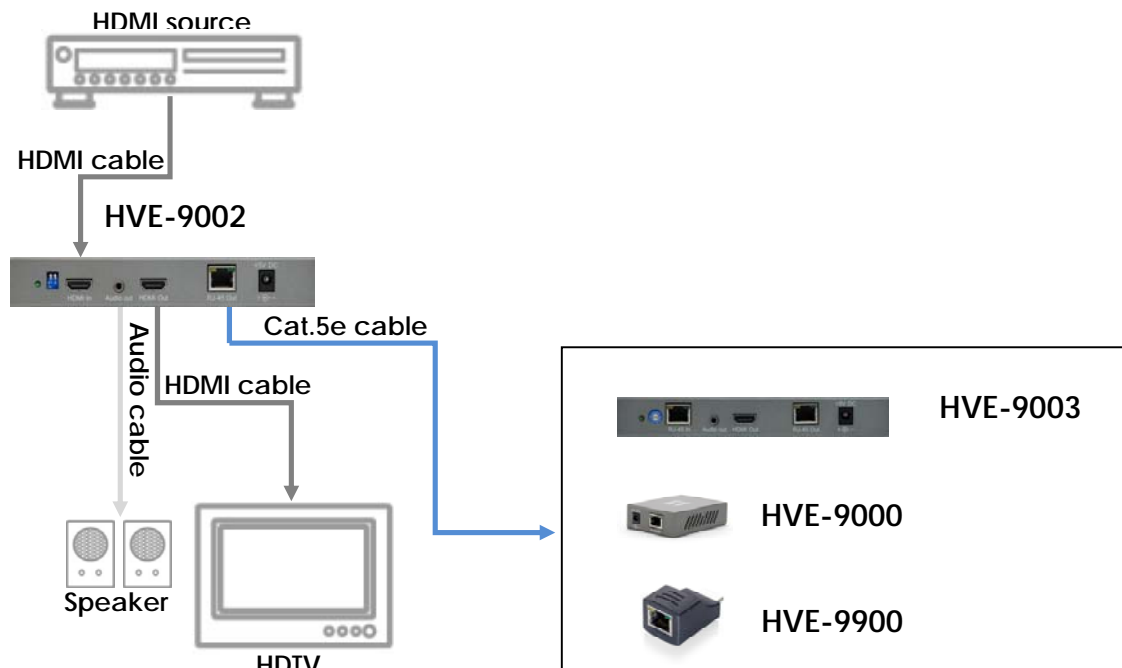

Relays HDMI signals to next cascading device with one local display

HVE-9003

1. Switch off all devices, including monitors.
2. Connect a local HDMI display to the HDMI Out of the HVE-9003 and then connect a speaker to the 3.5mm audio socket.
3. Connect to HVE-9003 via RJ-45 in by a Cat.5e cable.
4. Connect to next HVE-9003 (for cascading), to HVE-9000 (to HDTV at long range), or HVE-9900 (to HDTV at mid range) via RJ-45 out by a Cat.5e cable.
5. Plug in 5V4A DC power supply.
6. Power on the HDTV.

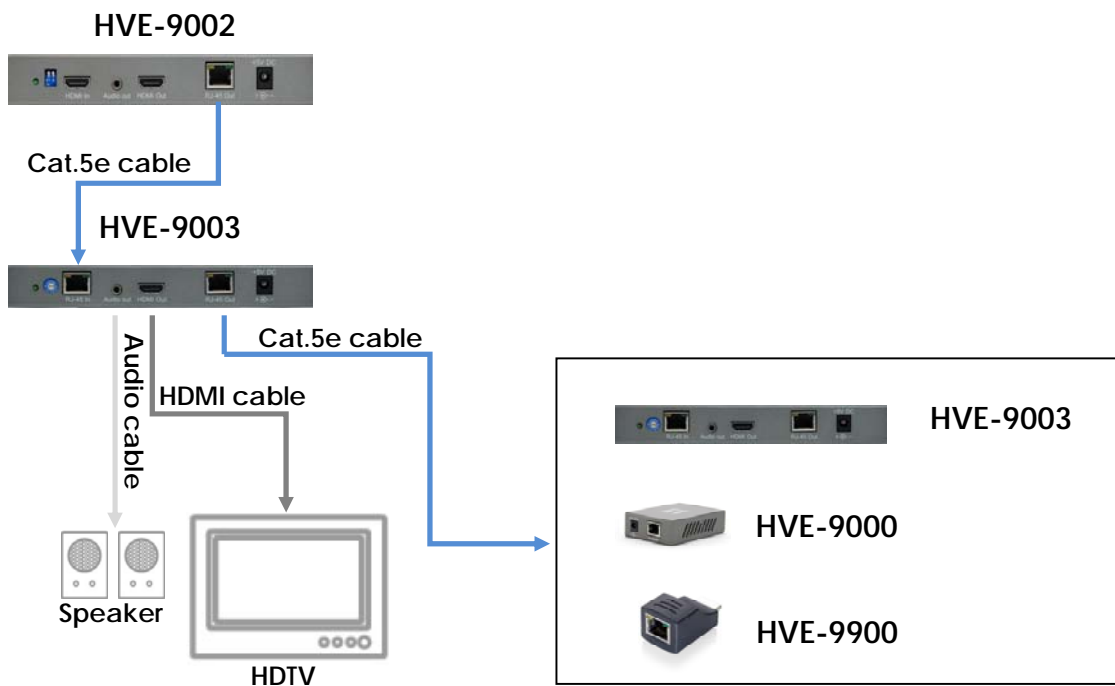

Systematic Application Diagrams

HVE-9002 & HVE-9003 with HVE-9000 & HVE-9900

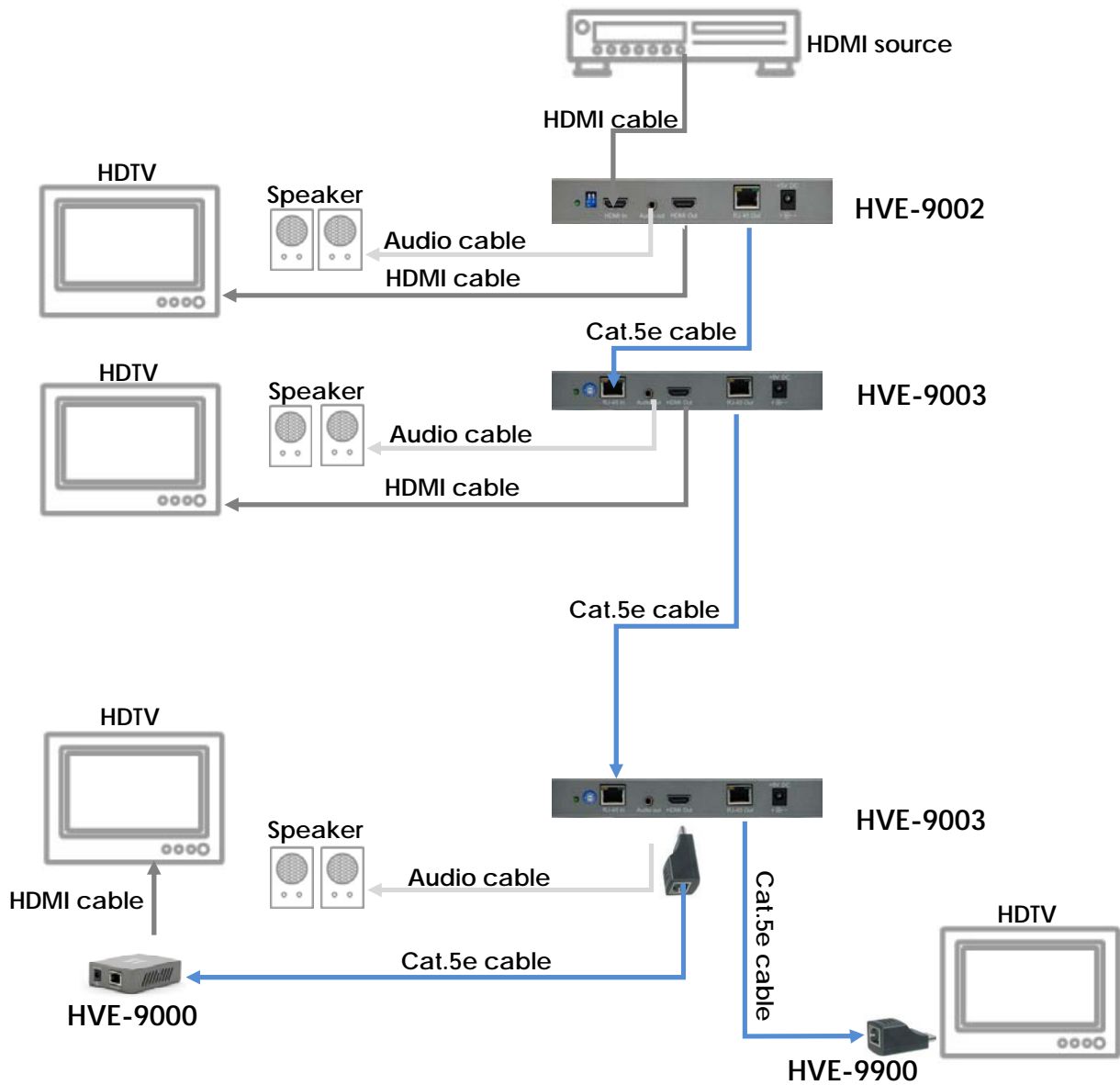

Frequently Asked Questions

How does equalizer (EQ) work?	Equalizer is a built in electronic device used to fine tune picture quality. Please turn knob anticlockwise from 7 to 0 to get the optimal vision. If you find the display is not showing properly, please check your cable connection or it is out transmission limit.
What is the minimum requirement of Cat-X cable	Minimum cable requirement is Category 5 cable for HDSpider™ series products. Please ensure all cables are terminated with RJ-45 plug according to EIA/TIA568B definition.
What kind of Cat-X cable is recommended?	We recommend using Category 6 or 7 STP cable for best picture quality at maximum extension. For better result please use cable with minimum delay skew.
I want extension above specification, is that possible?	Yes. To extend HDMI signal above specification published please use high quality HDMI cable (24 gauges) and recommended Cat-X cable. On field test, it is possible using CAT.6 cable for 50m transmission under 1080p. If further extension is required, please set HDMI source at 480p resolution.
I am using HVE-9900 to receive HDMI signal, but there is no image on monitor.	HVE-9900 is only intended to use for shorter transmission length. The maximum transmission length is at 15m under 1080p or 25m under 720p/1080i resolution. If your application exceeds this transmission limit, please use <u>HDSpider™ HDMI Cat.5 Receiver (Long)</u> (HVE-9000) instead.
There is no image on display, what could be the problem?	First please check all cable is properly installed. Secondly check display source is functioning correctly.
It is still not working.	If problem persist, please try the EDID learning function on HVE-9001 and HVE-9002 (stated on p.4-5).

Specifications

Model Name	HVE-9000	HVE-9001	HVE-9900
Package Contents	1x HVE-9000 1x 5V transformer 1x User Manual	1x HVE-9001 1x 5V transformer 1x User Manual	1x HVE-9900 1x User Manual
Video Bandwidth	1.65Gbps		
Resolution	480i – 1080p		
Transmission Length	60m under HD (720p/1080i) or 40m under Full HD (1080p)		
Audio channel	7.1-channel or stereo		
Supported signal	HDMI 1.2 & DVI 1.1		
Input	1x RJ-45	1x HDMI	1x RJ-45
Output	1x HDMI	1x RJ-45	1x HDMI
Power	5V 2A DC	5V 2A DC	None
HDMI Connector	19-pin female	19-pin female	19-pin female
RJ-45 Connector	2 indication LEDs	2 indication LEDs	2 indication LEDs
Housing	Metal	Metal	Plastic
Dimensions (L x W x H)	87 x 60 x 25 (mm)	87 x 60 x 25 (mm)	45 x 25 x 20 (mm)
Weight	160g	160g	25g

Model Name	HVE-9002	HVE-9003
Package Contents	1x HVE-9002 1x 5V transformer 1 x User Manual	1x HVE-9003 1x 5V transformer 1 x User Manual
Video Bandwidth	1.65Gbps	
Resolution	480i – 1080p	
Transmission Length	60m under HD (720p/1080i) or 40m under Full HD (1080p)	
Audio channel	7.1-channel or stereo	
Supported signal	HDMI 1.2 & DVI 1.1	
Input	1x HDMI	1x RJ-45
Output	1x HDMI (display or cascading) 1x RJ-45 1x 3.5mm audio socket	1x HDMI (display or cascading) 1x RJ-45 (cascadable) 1x 3.5mm audio socket
Power	5V 4A DC	5V 4A DC
HDMI Connector	19-pin female	19-pin female
RJ-45 Connector	2 indication LEDs	2 indication LEDs
Housing	Metal	Metal
Dimensions (L x W x H)	180 x 108 x 27 (mm)	180 x 108 x 27 (mm)
Net Weight	430g	430g

*Specification subject to change without notice

Notice

1. Please read user manual carefully before operating the device.
2. Please use the power adaptor accompanied with this product. Warranty does not cover for damages caused by pairing other power adaptor.
3. Please check all connecting devices are properly grounded to avoid electric failure.
4. This product has limited warranty for one year from defects in material and workmanship. Items that are physically damaged, misused, tempered with or altered are void of warranty. For further details please contact your distributor. In case warranty sticker is damaged or missing, warranty is void. For further details please contact your distributor.
5. If your HDMI (DVI) device requires an EDID present, you can use an EDID Reader/Writer to provide HDMI (DVI) EDID information.
6. All of the transmission distances are measured by using Belden Cat.5e 125MHz cables and PlayStation3 as the HDMI source.
7. To reduce the interference among the unshielded twisted pairs of wires in Cat.5/5e/6 cable, you can use shielded Cat.5/5e/6 cables to improve EMI problems, which is worsen in the long transmission.
8. Because the quality of the Cat.5/5e/6 cables has the major effects in how long transmission distance and how good the picture quality may be, the actual transmission length is subject to your Cat.5/5e/6 cables. For resolution greater than 1080i or 1280x1024, a Cat.6 cable is recommended.